



TECHNICAL SERVICE MANUAL

(Technischer service-handbuch)

VRC-MIX

Low & Medium pressure equipment for air spray & air assisted airless spray.

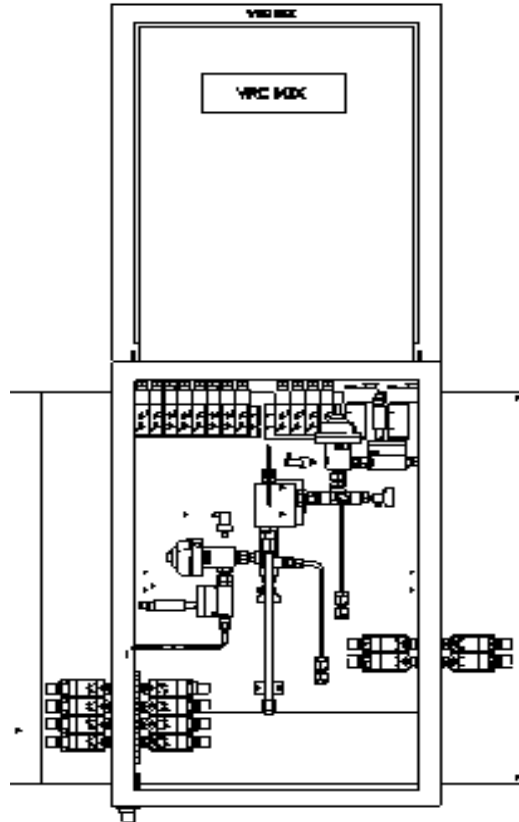

Serial Number:

V R COATINGS PVT.LTD

OFFICE: J-138, BHOSARI INDUSTRIAL AREA,PUNE MAHARASHTRA
INDIA-411026

WORKS:PLOT NO -136,SECTOR 7,PCNDTA BHOSARI,PUNE ,MAHARASHTRA
INDIA-411026

CONTACT US : sales@vrcoatings.com, www.vrcoatings.com, service@vrcoatings.com,

+91-020- 27130331
Mr. Pascal Dsouza (Technical Director)
+91-9822655891





TECHNICAL SERVICE MANUAL

(Technischer service-handbuch)

VRC-MIX

Low & Medium pressure equipment for air spray & air assisted airless spray.

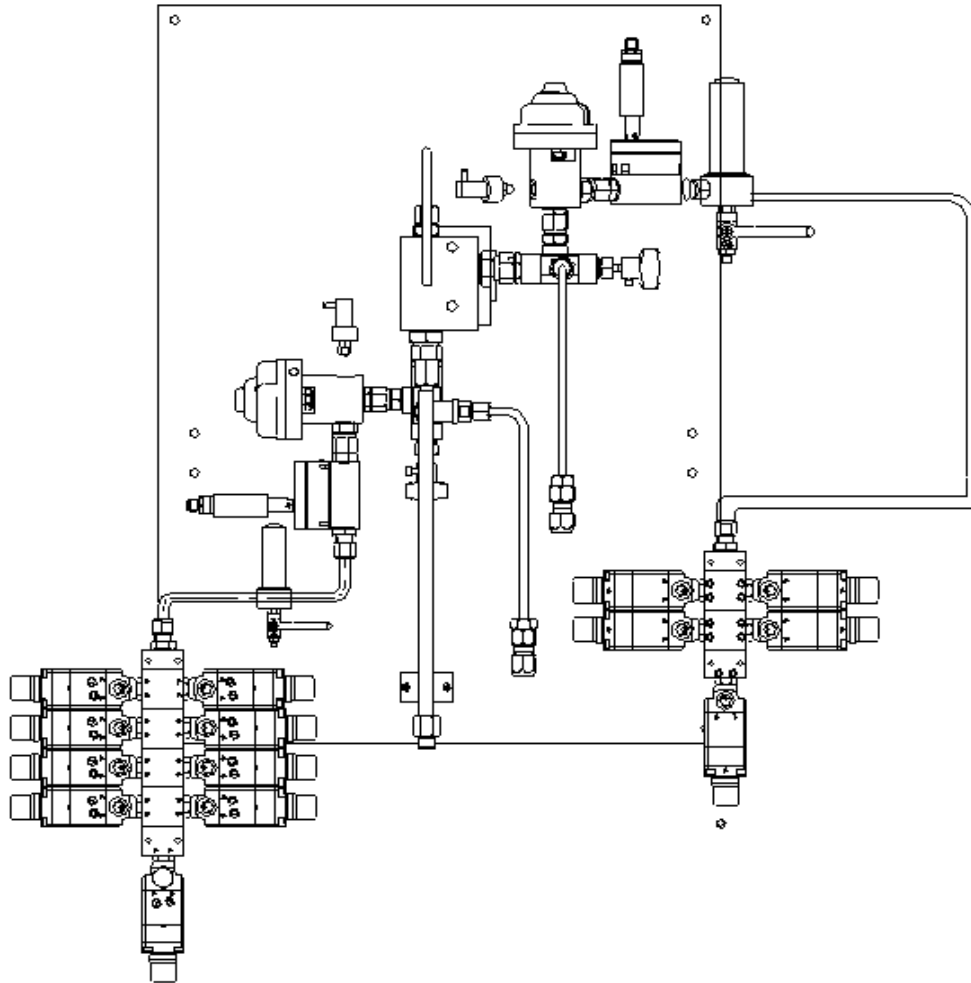

Serial Number:

V R COATINGS PVT.LTD

OFFICE: J-138, BHOSARI INDUSTRIAL AREA,PUNE MAHARASHTRA
INDIA-411026

WORKS:PLOT NO -136,SECTOR 7,PCNDTA BHOSARI,PUNE ,MAHARASHTRA
INDIA-411026

CONTACT US : sales@vrcoatings.com, www.vrcoatings.com, service@vrcoatings.com,

+91-020- 27130331
Mr. Pascal Dsouza (Technical Director)
+91-9822655891



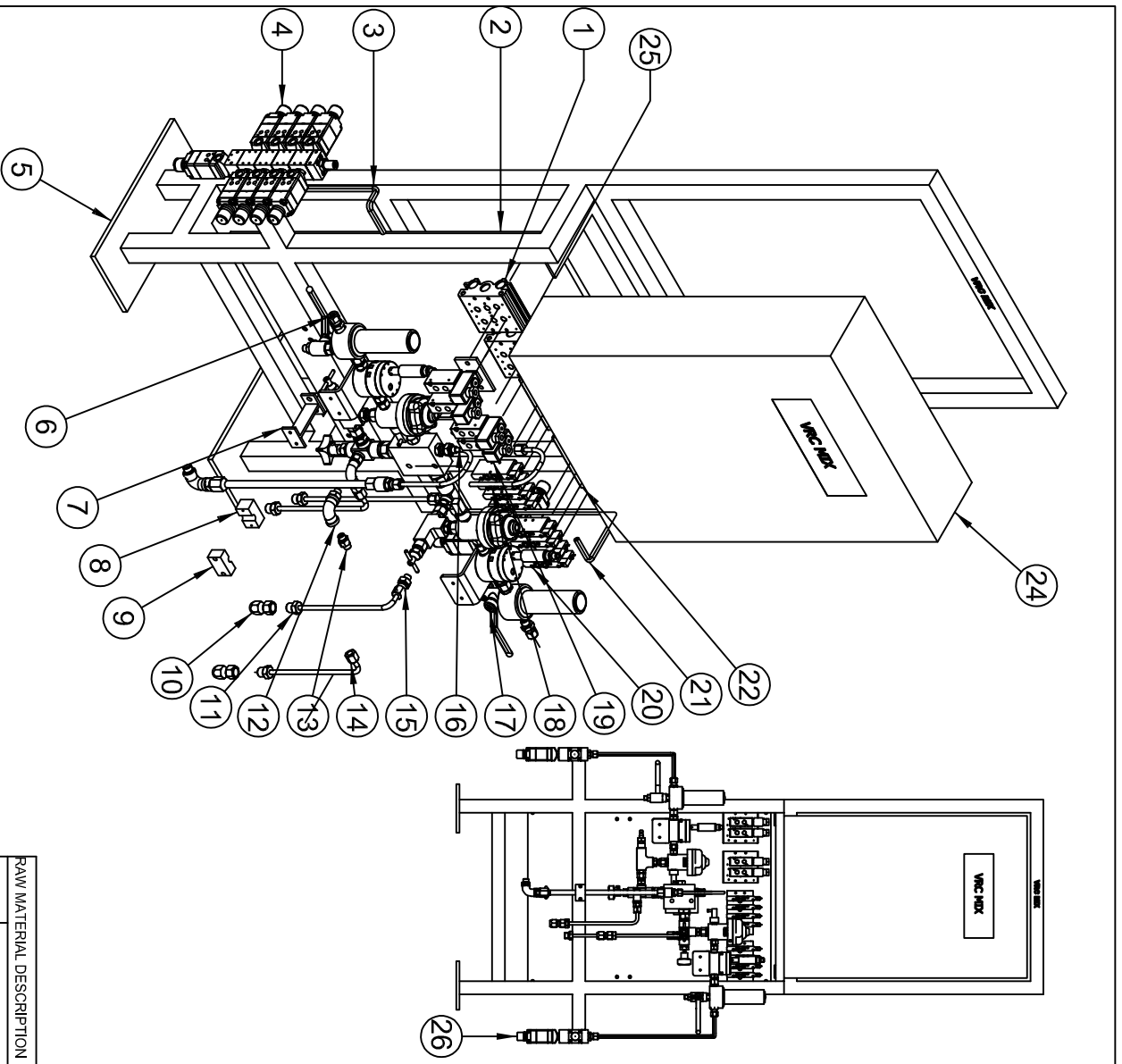

SR. NO.	PART NUMBER	PART NAME	QTY.	W & T
26	06 007 705 02	CCV ASSEMBLY	1	
25	03 117 118 52 V06	MANIFOLD 1/8" X 6 STAGE	1	
24	17 002 141 00	CONTROL PANEL BOX	1	
22	03 113 118 52 F06	MANIFOLD 1/8" X 4 STAGE	2	
20	03 116 118 52 FST	SOLENOID VALVE 5/2 WAY 1/8"	13	
19	03 116 114 52 FST	5/2 SOLENOID VALVE (FESTO MAKE)	4	
18	17 002 125 00	TUBE CONNECTING ASSEMBLY	1	
17	17 027 001 00	Manifold with ratio valves and flow meter	1	
16	24 086 014 07	BRACKET FOR MIXING BLOCK	1	
15	14 002 001 07	CONNECTOR 3/8"X1/4"	3	
14	17 002 123 00	TUBE CONNECTING ASSEMBLY	1	
13	14 001 001 19	CONNECTOR (1/4"X1/4")	1	
12	34 002 002 19	ELBOW 3/8"	1	
11	17 002 121 00	TUBE CONNECTING ASSEMBLY	1	
10	05 004 000 00	NOZZLE FILTER ASSLY	2	
9	17 002 129 07	TOP CLAMP	1	
8	17 002 128 07	BOTTOM CLAMP	1	
7	17 002 127 07	BRACKET	1	
6	17 014 096 00	FERULE FITTING 3/8" BSP X DIA. 10MM TUBE	2	
5	17 002 113 07	STAND FOR VRC MIX LP	1	
4	06 007 709 02	CCV ASSEMBLY	1	
2	17 002 115 07	BASE MTDG BOARD	1	
1	03 117 114 52 F02	MANIFOLD 2 STAGE 1/4" (5/2 WAY)	2	

RAW MATERIAL DESCRIPTION NOTE:

SIZE		
LENGTH		
MAT.		

ALL DIM. ARE IN MM UNLESS OTHERWISE STATED. FOR OPEN TOLERANCE AND SURFACE ROUGHNESS SEE STANDARD CHART DD-01/CH-01. REMOVE SHARP CORNERS. IN CASE OF DELUPT ASK.

VR COATINGS PVT. LTD. J-138, MIDC, BHOSARI, PUNE-411 026 INDIA	<table border="1"> <tr> <td>DRN.</td> <td>CKD.</td> <td>APRD.</td> <td>PART NAME</td> </tr> <tr> <td>AMOL.</td> <td>ALBERT</td> <td>RICHARD</td> <td>VRC MIX LP</td> </tr> </table>	DRN.	CKD.	APRD.	PART NAME	AMOL.	ALBERT	RICHARD	VRC MIX LP
DRN.	CKD.	APRD.	PART NAME						
AMOL.	ALBERT	RICHARD	VRC MIX LP						
SCALE: NOT TO SCALE	PART NO. 17 027 000 03								

VRC-MIX (LP & Medium) Pressure Equipment.

INTRODUCTION:

This is an advance variable ratio, electronic operated two component mixing equipment.

With a high accuracy metering device by assistance of a high precision gear type flow meter to handle large mixing ratio ranges upto 30:1 (in 0.1 increments) along with a flow rate range of 0.1 to 4 liters per min.

Especially for multi-color application use, with provisions of online monitoring selection and flushing / purging facilities.

Provision of Modular bank (CCV banks) auto selection for multiple Base colors and multiple Activator with varying ratio input as required for variety of color combination mixing.

Material consumption monitoring, Pot life monitoring, Pressure monitoring, Tank level monitoring (optional) provisions are possible.

The system includes a unique design of mixing manifold assembly with inherent NRV for each part of component. Superior SS static mixture for quality and efficient Two part component mixing

Auto ON/OFF valves post flow meters with pressure transmitter connected to give a feed back to maintain required flow and mixing ratios.

Pre filter to the flow meters at out end of CCV bank to avoid clogging of flow meters to achieve best performance of these flow meters.

CCV banks with dedicated solvent flush and Air purge valves to help in flushing of mixed material when not in use or when there is a change in color. (Auto process cycle /manual provisions provided in programming)

Bypass manual Ratio check valves with nozzles to physically cross check /calibrate exact mixing ratios of individual part of two components.

Mechanical Operation:

The VRC-MIX (LP) has only two mechanical operations which need to be carried out, Manual ratio check (verification) of individual components, Pre mixing other being draining LP filter for cleaning and maintenance. All actuation of valves and solenoids are done by HMI provided.

POT life measurement, consumption data, Pressure values, selection of mixing ratio, selection of specific recipes for individual components are done on PLC programmed HMI.

Manual Ratio Check:

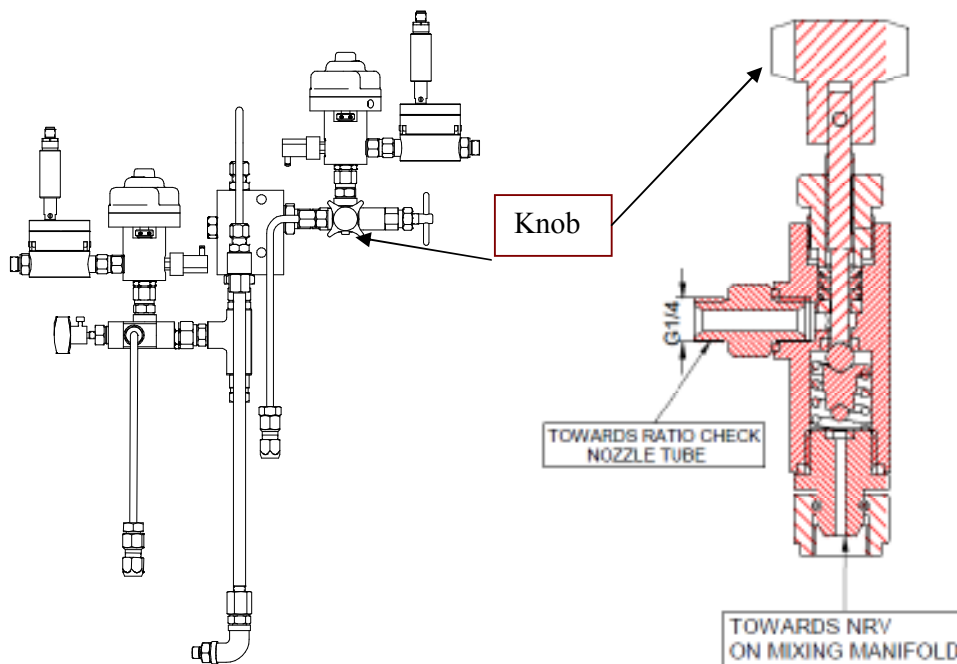

- For individual A & B component a Manual ratio check valve is provided.
- This valve has a double seat, when the Knob as shown in fig is tightened flow from metering valve to the mixing valve is bypassed to the ratio check nozzle for manual checking.
- On selecting ratio check mode on the HMI material shall start flowing into the nozzle.
- Both A & B component valves need to be actuated on same time for exact ratio.
- The manual ratio valve has a extension pipe attached with a filter and nozzle assembly.
- Individual containers to collect and measure the ratio of each component are placed bellow these individual nozzles.

Pre Filter drain:

- A pre filter is provided in line of the individual flow meters to avoid any foreign particles from entering these precision flow meters.
- This LP filter is provided with a drain ball valve at the base to drop pressure and assist during filter cassette replacement or cleaning

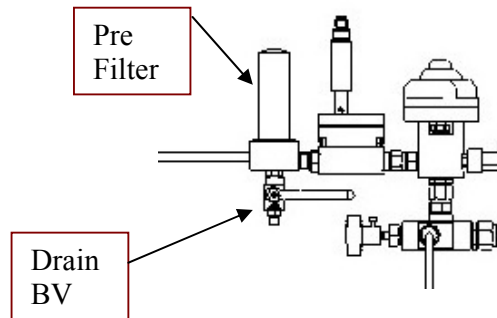
**General construction:**

- A general VRC-Mix consists of a mixing manifold assembly with static mixture.
- Connected to this mixing manifold are the ratio check valves to which high precision flow meters, metering valves and pre filters are fixed.
- Inlet to these pre filters is given through a color change valve bank.
- A color change valve bank consists of individual CCV for individual component type, solvent for flushing and 1 for air purge.
- Individual CCVS are fixed to a paint supply line from a paint kitchen. Return line is usually circulated through these CCV to avoid settling.
- In case of common solvent, lines can be looped with A part and B part CCV banks.

General VRC-MIX Hydraulic Layout:

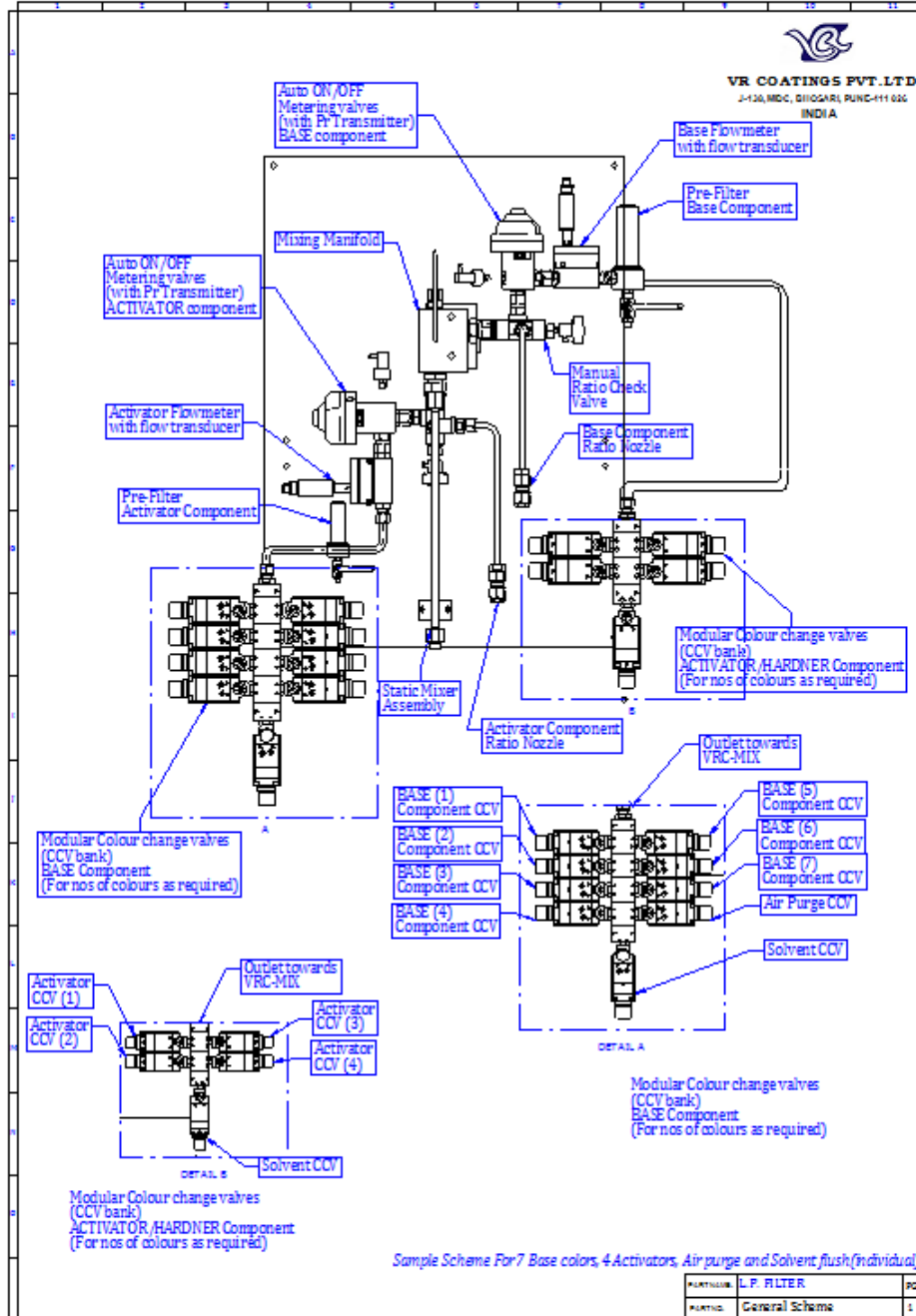

Material Flow Sequence:

- The no's of CCV's on individual A & B part component banks are selected and connected in a modular fashion on the basis of individual requirements.
- The outlet of CCV banks is given to the Pre filter.
- High precision flow meters are connected to these Pre filters.
- At outlet of flow meters is a metering valve and pressure transmitter.
- Feed back of the flow through the flow meter is programmed to actuate these metering valves to acquire desired preset mixing ratio volumes.
- Outlet of metering valves is connected to a manual ratio check valve which is operated manually to verify pre set mixing ratio to actual volumes.
- Material through the mixing manifold flows through a static mixture for efficient mixing.
- Static mixture outlet is connected to the drop point lines of airless or air assisted guns.
- Pre programmed Recipes when selected actuate respective CCVs connected to a solenoid bank to get required color.
- Flush cycle actuates Solvent ccv to flush complete post mix line to avoid curing.
- Flush timing can be timed and programmed.
- Air purge CCV opens when purge cycle is operated.

OPERATIONAL SEQUENCE:-

At Power On, the PLC and the HMI (Display) initialize and after internal checks, the following Ratio screen is displayed.

01/11/19 VRC MIX LP 13:46:23

SET RATIO

45.6



Mfg. By,
V R Coatings Pvt Ltd
VR Coatings Pvt. Ltd, MIDC, Bhosari, Pune.



This is ratio screen and it displays the selected volumetric ratio value.

Press "MAIN" key for the following screen.



STATUS

VR COATINGS PVT LTD

NT RDY	AUTO OFF	MANUAL	HEALTHY	CALIB OFF
--------	----------	--------	---------	-----------

BASE PRESSURE: 456 BAR

ACT PRESSURE: 456 BAR

RECIPE: 6

SET RATIO: 45.6 : 1

ACT RATIO: 34.56 : 1



This is the main screen display. Base and Activator line pressures are displayed in real time. The main screen also shows the set and actual mixing ratio in real time when the machine is under operation.

When spray operation is on, "SPRAY ON" is displayed.

When flushing operation is on, "FLUSH ON" is displayed.

When calibration process is on, "CALIB ON" is displayed.

Flushing, Spraying are available at bottom of auto off and manual commands in above screen.

At a time, any one of these operations can be executed.

The screen also shows system condition as "HEALTHY", if there is no fault.

The Auto or Manual status is displayed as per the respective mode selection.

Note: At a time, since one of the three operations can be on, only one message is displayed at any given time. If none of the three operations is on, no message is displayed.

There are three soft keys on this screen.

A) RATIO :-

Press ratio key to jump back to ratio screen.

B) LOGIN:-

To access the setting parameters proper login is essential. Press Login key and enter appropriate password to access the main menu screen. Note that menu key becomes visible only after proper login.

C) MENU:-

Use menu key to access the main menu screen.

When Menu key is pressed, following screen appears.

MENU



This Main-menu screen leads to different functions of the machine.

A)IO LIST –

Pressing this soft key the following screen is displayed. This key leads to a series of screens one after the other, which give a complete list of machine IO (inputs-outputs) to the PLC. It also shows the current status of each IO whether on or off. This feature is very useful for both, initial wiring and later on, troubleshooting. If the system manual is not at hand, the electrical maintenance team can refer to this in-built IO list in order to wire-up or check connectivity, functioning of individual component. It gives a complete list of IO, first a list of inputs and then the list of output.

Here we can see the PLC inputs and outputs used in the system alongwith their status (on/off). The On status is indicated by green colour and Off status by red colour.



INPUT LIST

V R COATINGS PVT LTD

ADDRESS	DESCRIPTION	STATUS
X0	BASE MAG PLS	OFF
X1	ACT MAG PLS	OFF
X2	BASE MAG PLS CNT	OFF
X3	ACT MAG PLS CNT	OFF
X4	SPARE	OFF
X5	FLUSH ON/OFF SW	OFF
X6	EMG STOP PB	OFF
X7	SPRAY ON/OFF SSW	OFF

OUTPUT LIST



Press “NEXT” key to go to next screen. Press “output list” key to jump to output list screen and “HOME” key to jump to main screen.



INPUT LIST

V R COATINGS PVT LTD

ADDRESS	DESCRIPTION	STATUS
X10	FAULT ACK PB	OFF
X11	RECIPE-1 SW	OFF
X12	RECIPE-2 SW	OFF
X13	RECIPE-3 SW	OFF
X14	RECIPE-4 SW	OFF
X15	RECIPE-5 SW	OFF
X16	RECIPE-6 SW	OFF
X17	RECIPE-7 SW	OFF



OUTPUT LIST



Press “NEXT” key to go to next screen, “output list” key to jump to output list screen, “HOME” key to jump to main screen and “BACK” key to go back to previous screen.



INPUT LIST

V R COATINGS PVT LTD

ADDRESS	DESCRIPTION	STATUS
X20	RECIPE-8 SW	OFF
X21	RECIPE-9 SW	OFF
X22	RECIPE-10 SW	OFF
X23	SPARE	OFF
X24	RATIO INCREMENT	OFF
X25	RATIO DECREMENT	OFF
X26	SPARE	OFF
X27	SPARE	OFF



OUTPUT LIST



Press “NEXT” key to go to next screen, “output list” key to jump to output list screen, “HOME” key to jump to main screen and “BACK” key to back to previous screen.



OUTPUT LIST

V R COATINGS PVT LTD

ADDRESS	DESCRIPTION	STATUS
Y0	BASE METER SV	OFF
Y1	ACT METER SV	OFF
Y2	AIR PURGE SV	OFF
Y3	SPARE	OFF
Y4	BASE FLUSH SV	OFF
Y5	ACT FLUSH SV	OFF
Y6	SPARE	OFF
Y7	FAULT LAMP	OFF



INPUT LIST



Press “NEXT” key to go to next screen, “INPUT LIST” key to go back to input list screen and “HOME” key to jump to main screen.



OUTPUT LIST

V R COATINGS PVT LTD

ADDRESS	DESCRIPTION	STATUS
Y10	READY LAMP	OFF
Y11	AUTO ON LAMP	OFF
Y12	HOOTER	OFF
Y13	BASE CCV-1 SV	OFF
Y14	BASE CCV-2 SV	OFF
Y15	BASE CCV-3 SV	OFF
Y16	BASE CCV-4 SV	OFF
Y17	BASE CCV-5 SV	OFF





Press "NEXT" key to go to next screen, "INPUT LIST" key to go back to input list screen, "HOME" key to jump to main screen and "BACK" key to go back to previous screen.



OUTPUT LIST

V R COATINGS PVT LTD

ADDRESS	DESCRIPTION	STATUS
Y20	BASE CCV-6 SV	OFF
Y21	BASE CCV-7 SV	OFF
Y22	ACT CCV-1 SV	OFF
Y23	ACT CCV-2 SV	OFF
Y24	ACT CCV-3 SV	OFF
Y25	ACT CCV-4 SV	OFF
Y26	SOLVENT-1 SV	OFF
Y27	SOLVENT-2 SV	OFF





Press "NEXT" key to go to next screen, "INPUT LIST" key to go back to input list screen, "HOME" key to jump to main screen and "BACK" key to go back to previous screen.

**OUTPUT LIST**

V R COATINGS PVT LTD

ADDRESS	DESCRIPTION	STATUS
Y30	SPARE	OFF
Y31	SPARE	OFF
Y32	SPARE	OFF
Y33	SPARE	OFF
Y34	SPARE	OFF
Y35	SPARE	OFF
Y36	SPARE	OFF
Y37	SPARE	OFF

**INPUT LIST**

Press “INPUT LIST” key to go back to input list screen, “HOME” key to jump to main screen and “BACK” key to go back to previous screen.

B)READY CONDITION –

Following screen shows the ready conditions required for system to run in Auto mode.



AUTO CYC READY CONDITIONS

RECIPE: 6

VR COATINGS PVT LTD

SR	DESCRIPTION	IDLE	STATUS
1	BASE PRESSURE HEALTHY	ON	OFF
2	ACT PRESSURE HEALTHY	ON	OFF
3	AUTO MODE	ON	OFF
4	CALIB CYCLE	OFF	OFF
5	FAULT	OFF	OFF



The screen shows the check points, their ideal and actual status. To run the system in auto mode, actual status of these parameters must match with ideal status. If there is a mismatch, take appropriate corrective action so that the conditions match.

C)FAULT-

This key leads to fault messages screen as shown below.



In case of any operational abnormality the system generates appropriate faults and informs the user via audio-visual alarms (hooter and highlighted text message along with fault lamp). The fault will be displayed on the fault screen, which is accessible through the fault soft key provided on MAIN MENU screen. In case of a fault or warning, press the “Fault Ack” key to shut-off the hooter. Remove the reason for the fault and then reset the fault again. Press “MENU” key to jump to menu screen.

D)MANUAL CONTROLS –

This screen is to be used for operating individual valves manually. This mode is useful for installation as well as periodic checks and maintenance activity. In addition, the flushing keys can be used for flushing the system manually.



MANUAL CONTROLS

RECIPE: 6

VR COATINGS PVT LTD

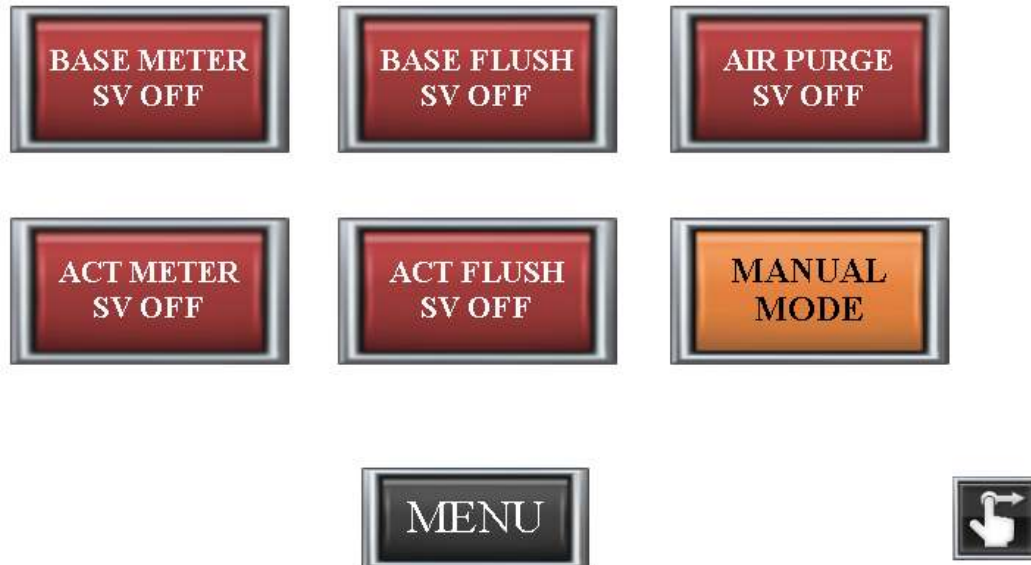

1) Base Meter SV:-

Operate the command key (BASE METER SV OFF) for this parameter to make base meter valve on. The status shows “ON” in green. To make it off, press again the same key. The valve shuts off and the status again turns to “OFF” in red.

2) Act Meter SV:-

Operate the command key (ACT METER SV OFF) for this parameter to make activator meter valve on. The status shows “ON” in green. To make it off, press again the same key. The valve shuts off and the status again turns to “OFF” in red.

3) Base Flush SV:-

Operate the command key (BASE FLUSH SV OFF) for this parameter to make base meter valve on. The status shows “ON” in green. To make it off, press again the same key. The valve shuts off and the status again turns to “OFF” in red.

4) Act Flush SV:-

Operate the command key (ACT FLUSH SV OFF) for this parameter to make activator meter valve on. The status shows “ON” in green. To make

it off, press again the same key. The valve shuts off and the status again turns to “OFF” in red.

5) Air Purge SV:-

Operate the command key (AIR PURGE SV OFF) for this parameter to make Air purge valve on. The status shows “ON” in green. To make it off, press again the same key. The valve shuts off and the status again turns to “OFF” in red.

Press “NEXT” key to go to next screen, “HOME” key to jump to main screen.



MANUAL CONTROLS

RECIPE: 6

VR COATINGS PVT LTD

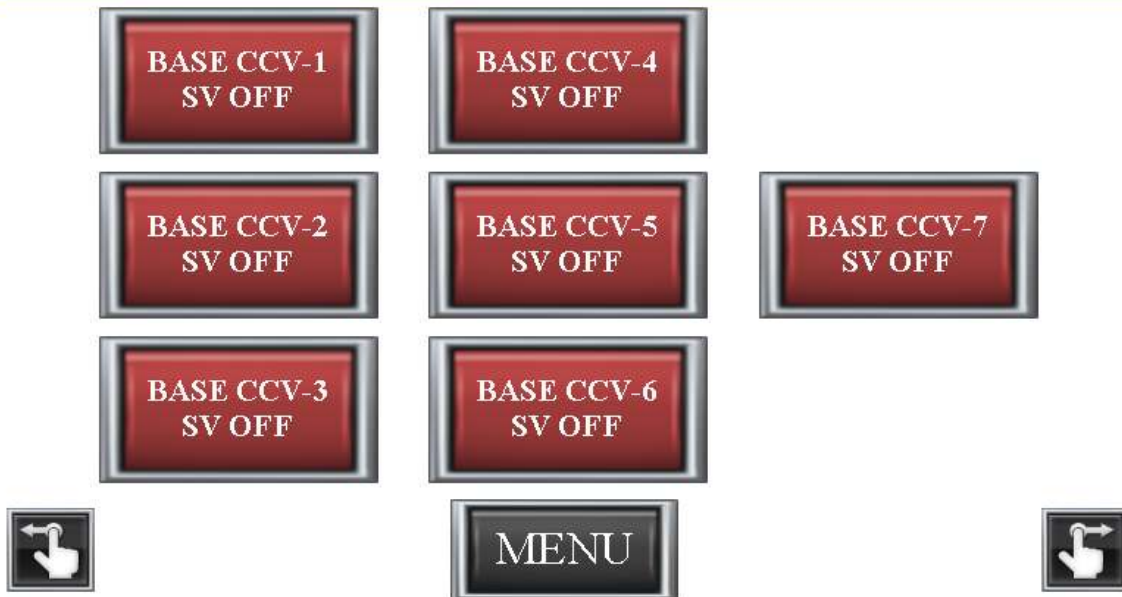

The screen displays a grid of control buttons for manual operations. The buttons are arranged as follows:

- Top row: BASE CCV-1 SV OFF, BASE CCV-4 SV OFF
- Middle row: BASE CCV-2 SV OFF, BASE CCV-5 SV OFF, BASE CCV-7 SV OFF
- Bottom row: BASE CCV-3 SV OFF, BASE CCV-6 SV OFF
- Bottom center: MENU
- Bottom left and right: Navigation icons (a hand with a left-pointing arrow and a hand with a right-pointing arrow).

Press “NEXT” key to go to next screen, “HOME” key to jump to main screen and “BACK” key to go back to previous screen.



MANUAL CONTROLS

RECIPE: 6

VR COATINGS PVT LTD

ACT CCV-1
SV OFF

ACT CCV-3
SV OFF

ACT CCV-2
SV OFF

ACT CCV-4
SV OFF



MENU



Press “NEXT” key to go to next screen, “HOME” key to jump to main screen and “BACK” key to go back to previous screen.

E)TOTALISER: –

This screen shows the approximate paint consumption in both cumulative and resettable basis, for both components.



TOTALISER

RECIPE: 6

VR COATINGS PVT LTD

SR	DESCRIPTION	TOTAL	RESETTABLE	
1	BASE	12345.6	12345.6	RESET
2	ACTIVATOR	12345.6	12345.6	RESET

MENU

Base Total – Shows the base consumption. This count resets at logical overflow. Range up to 12345.0ltrs.

Act Total – Shows the activator consumption. This count resets at logical overflow. Range up to 12345.0 ltrs.

Note: Both of these totalizers are non-resettable and automatically resets at overflow.

Base Resettable-- Shows the base consumption from last reset and can be reset when RESET key is pressed. Range up to 12345.0ltrs.

Act Resettable -- Shows the activator consumption from last reset and can be reset when RESET key is pressed. Range up to 12345.0ltrs.

Note: Both the totalizers show approximate readings with reasonable tolerance since rounded off to one decimal. Actual consumption may be slightly different from that which is displayed.

F) MODE SELECT-

At menu screen, press ‘Mode Select’ key to access the calibration setting screen; as shown below. Refer the schematic on page 30 above. For carrying out the calibration or manual ratio check, open valves AY and BY fully. Now refer the following screen.

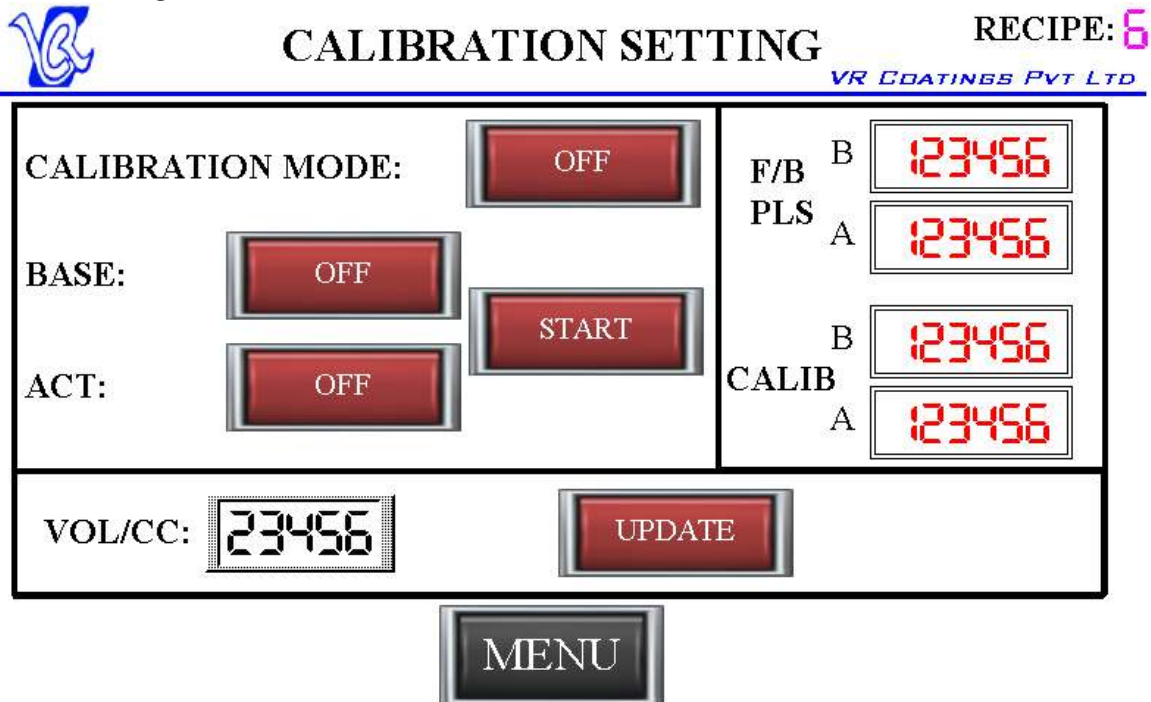

CALIBRATION SETTING RECIPE: 6

VR COATINGS PVT LTD

CALIBRATION MODE:	OFF		F/B B	123456
			PLS A	123456
BASE:	OFF	START		
ACT:	OFF		CALIB B	123456
			CALIB A	123456
VOL/CC:	23456			
				UPDATE

MENU

Note: - Sometimes after fresh installations or after servicing of pumps or changing of pumps, calibration of pumps is recommended.

Sometimes you find pumps are ok, everything is correct in individual component testing but mixing ratio in manual ratio check is not correct. Then also recalibration of equipment is necessary.

This screen is to be used to calibrate the pumps as and when required. It is recommended that the pumps be calibrated every six months as maintenance activity.

To calibrate Base Pump:

- a) Press the “OFF” key for calibration mode select. The status will now show “ON”.
- b) Open the ratio valve ‘BY’ on the mixing manifold assembly.
- c) Keep an empty container below the Base outlet.
- d) Press “OFF” key in front of the command “Base Select”. It shows ‘ON’.
- e) Press “START” key. The status changes to “ON” and the base material is collected in the container.
- f) When a sizable material is collected, make the “START” command key “OFF”. The status adjacent to it will also show “OFF”. Now the base material will stop.

Measure the dispensed base material in a calibrated beaker.

Now enter the measured volume in “Volume/cc” field at the bottom of the screen. Press “UPDATE” key. Base pump is now calibrated. Make the ‘Base select’ and ‘Calibration mode select’ keys off. **Close the valve ‘BY’ again.** The base and act field at the right side top of screen shows the running pulses during calibration.

The base and act field below feedback pulses shows the final calibrated pulses.

To calibrate Activator Pump:

- a) Press the “OFF” key for calibration mode select. The status will now show “ON”.
- b) Open the ratio valve ‘AY’ on the mixing manifold assembly.
- c) Keep an empty container below the Activator outlet.
- d) Press “OFF” key in front of the command “Act Select”. It shows ‘ON’.
- e) Press “START” key. The status changes to “ON” and the activator material is collected in the container.
- f) When a sizable material is collected, make the “START” command key “OFF”. The status adjacent to it will also show “OFF”. Now the Activator material will stop.

Measure the dispensed activator material in a calibrated beaker.

Now set the measured volume in “Volume/cc” field at the bottom of the screen. Press “UPDATE” key. Activator pump is now calibrated. Make the “Act select” and ‘Calibration Mode Select’ keys Off. **Close the valve ‘AY’ again.**

Refer the following diagram for calibration:

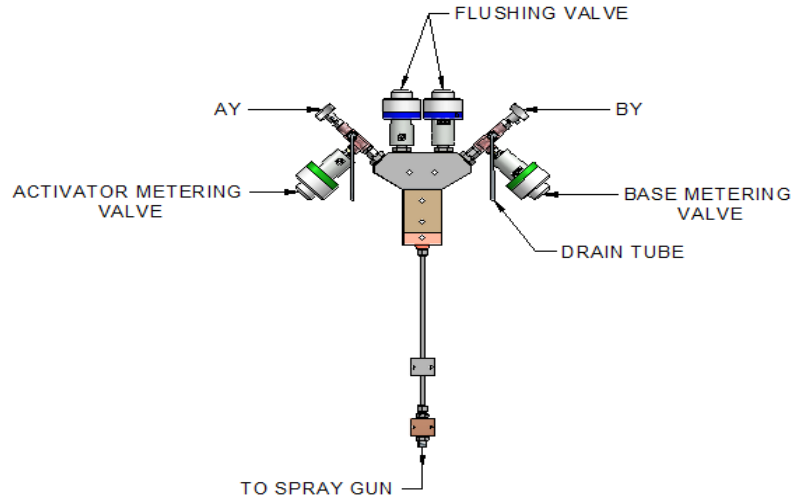

In Manual Ratio check & Calibration mode

* Open AY' & BY' needle valves

* Put vessels below drain tube to collect both components.

MIXING MANIFOLD ASSEMBLY

G) LOGIN-

Press Login key to access the main login screen, which is shown below.

Appropriate login is required to enter into required setting mode.

Main login screen is shown as shown below:-

RECIPE: 6

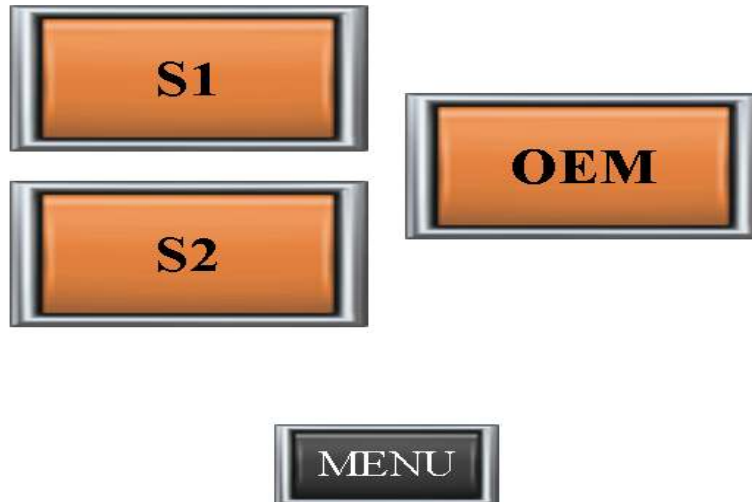

Press Login key, enter authorized password. The above mentioned keys become visible. They represent two sets of supervisory parameters.

Each key gives access to different setting screens.

When “S1” (Supervisor 1) key is pressed, following screen appears.

Pressure Monitoring can be made enable or disabled. For this parameter, value “0” indicates “Disable” and “1” indicates “Enable”.

The pressure range can be set up to 456 Bar. Set the pressure range shown on the respective pressure transmitter. Presently, both the transmitters have 25Bar range.

The transmitters show Base and Activator line pressure on real time.



USER SETTING-S1

RECIPE: 6

VR COATINGS PVT LTD

SR	DESCRIPTION	SETTING
6	BLPBP	456 bar
7	ALPBP	456 bar
8	POT LIFE TIME	456 min
9	ACTIVATOR NO.	6
10	SOLVENT 1/2 SELECT	6
11	FLUSH AUTO/MANUAL	6



WRITE

MENU

OEM

S2



BLPBP refers to "Base Low Pressure Blocking Pulses". High speed pulse counts for Base get neglected below this pressure to enhance process accuracy.

ALPBP refers to "Activator Low Pressure Blocking Pulses". High speed pulse counts for Activator get neglected below this pressure to enhance process accuracy.

Pot Life Time:-

Set the pot life period in minutes for the paint being used, as specified by the paint manufacturer. The system monitors the time between successive spray Off and On commands and raises a Pot life alarm when the set pot life is about to expire without the mixed paint being used so that the system can be flushed to avoid gelling. Refer the "Warnings and fault" table for fault reset procedure.

ACTIVATOR NO.: Set the desired activator number for the recipe (colour) being set. Once set, whenever this recipe (colour) is selected, the corresponding activator will be selected for spray operation.

SOLVENT '1/2' : Select the solvent type (1 or 2) to be used. Please set appropriate solvent for the base and activator assigned to the recipe.

FLUSH AUTO/MAN: Set desired flushing mode for the recipe. Set '1' for Auto flush and set '0' for manual flush. If auto flushing is set, whenever there is a recipe change from current recipe to some other recipe, auto flushing is executed as per the flushing parameters (timing) set for the old recipe.



USER SETTING-S1

RECIPE: 6

VR COATINGS PVT LTD

SR	DESCRIPTION	SETTING
12	PRESSURE CHECK DLY	45.6 SEC
13	RATIO CHECK DLY	45.6 SEC
14	RATIO CHECK EN/DB	3456
15	POT EWF	56 MIN



WRITE

MENU

OEM

S2



PRESURE CHK DELAY:-It represents pressure check delay. The Delay required for pressure check to start can be set here. This is executed only once after each spray On.

RATIO CHK DELAY:-It represents ratio check delay. The Delay required for ratio check to start can be set here. This is executed only once after each spray On.

RATIO CHK EN/DB:-Ratio check can be enabled (1) or disabled (0) by this parameter.

POT EWF:-This is the Pot life early warning factor in minutes. It is a warning used to prevent a possible pot life fault before the expiry of the set pot life time. For example, if the Pot life is set 90 Mins and Pot EWF is set 10 Mins, then if there is a spray On and Off and no spray On again within $(90-10=)$ 80 Mins, it will give a warning of EWF. In such a case, it is advisable to flush the system. It will prevent line choking.

FLUSH SETTING

RECIPE: 6

SR	DESCRIPTION	SETTING
1	FLUSH TIME BASE	345.6 sec
2	FLUSH TIME ACT	345.6 sec
3	B. FLUSH ON DLY	345.6 sec
4	A. FLUSH ON DLY	345.6 sec
5	FIRST SOLVENT C/S	345.6 sec

BACK

WRITE

MENU

OEM

S2

NEXT

FLUSH TIME BASE: Set the total Base flushing cycle time for auto-flushing. Once set, the base line is flushed for this total time. This period includes all the solvent-air cycles executed as per the parameters set.

FLUSH TIME ACTIVATOR: Set the total Activator flushing cycle time for auto-flushing. Once set, the activator line is flushed for this total time. This period includes all the solvent-air cycles executed as per the parameters set.

B.FLUSH ON DLY: Set the On delay time of the base flushing cycle after the flushing cycle is activated.

A.FLUSH ON DLY: Set the On delay time of the activator flushing cycle after the flushing cycle is activated

FIRST SOLVENT C/S: Set the pilot solvent cycle time for flushing the lines. During auto flush cycle, first solvent is passed for this time period to clean the previous paint from the hoses/guns. This is executed only once.

FLUSH SETTING

RECIPE: 6

SR	DESCRIPTION	SETTING
6	FIRST AIR PURGE	345.6 sec
7	SUB SOLVENT C/S	345.6 sec
8	SUB AIR PURGE	345.6 sec

BACK

WRITE

MENU

OEM

S2

NEXT

FIRST AIR PURGE: Set the pilot air cycle time for flushing the lines. During auto flush cycle, air is passed for this time period after the first solvent cycle as described above. This is executed only once.

SUB SOLVENT C/S: Set the time period for all subsequent solvent cycles. This is a kind of fine tuning after the first solvent and air cycles are done to ensure efficient line flushing. After the first air purge described above, solvent is again passed for this time period.

SUB AIR PURGE: Set the time period for all subsequent air cycles. This is a kind of fine tuning after the first solvent and air cycles are done to ensure efficient line flushing. After the subsequent solvent cycle described above, air is again passed for this time period.

Press “NEXT” key to go to next screen, “HOME” key to jump to main screen and “BACK” key to go back to previous screen.

Press “S2” key to go back to supervisory setting 2 screen.

Press “OEM” key to go back to OEM setting screen.

WRITE key: To save or write parameters, use manual mode (on manual controls screen). When any or all parameters of a recipe are set/edited, press the ‘WRITE’ key till the hooter sounds. The settings or changes made are saved to the recipe.

NOTE: If this key is not pressed after setting/changing any or all parameters, then changes do not take effect and earlier values prevail.

Following screen appears when S2 key is pressed .Following screen appears when S2 key is pressed.



USER SETTING-S2

RECIPE: 6

VR COATINGS PVT LTD

<p>RATIO SET</p> <p>45.6</p> <p>VIA SW</p>	<p>1 ST SCAN:- 23456 *10 mSec</p> <p>2 ST SCAN:- 23456 *10 mSec</p> <p>RATIO SCAN:- 23456 *10 mSec</p>
--	---

WRITE

F/B

MENU

S1

OEM

This screen displays the ratio that has been set. “Ratio via HMI” means user can change and set the required ratio via HMI.

In such case, press the “Ratio via Switch” key, it changes to “Ratio via HMI” and user can now set ratio via HMI; i.e by soft key pad.

Parameter no.1 and 2 indicates the 1st and 2nd Ratio scan Time respectively.

Parameter no.3 represents the Ratio scan time. Set a bigger scan time for first, smaller scan time for the second and least scan time for the regular setting (Ratio scan).

Normally, there is no need to change the factory settings in these parameters.

Press “F/B” key to go back to feedback screen.

	SET	ACTUAL	RECIPE: 6
RATIO:	45.6	34.56	POT LIFE: 456 min

BASE PRS: 456 bar	F/B	BASE-	123456
	PLS:	ACT-	123456
ACT PRS: 456 bar	CALIB	BASE-	123456
	PLS:	ACT-	123456



Press "S1" key to go back to supervisory setting 1 screen.
 Press "OEM" key to go back to OEM setting screen.
 Press "MENU" key to jump back to menu screen.
 OEM setting screen appears when OEM key is pressed and OEM password is entered. Please **DO NOT** change any settings on this page. Consult the OEM or your supplier if needed.

PLEASE NOTE YOUR PARAMETER SETTINGS HERE FOR FUTURE REFERENCE:

SAFETY LABELS AND NAMEPLATE



Label on pump

Label no.W.01



Label on pump provided without coupling guard.

Label no.W.02



Label on pump provided with coupling guard.

Label no.W.03

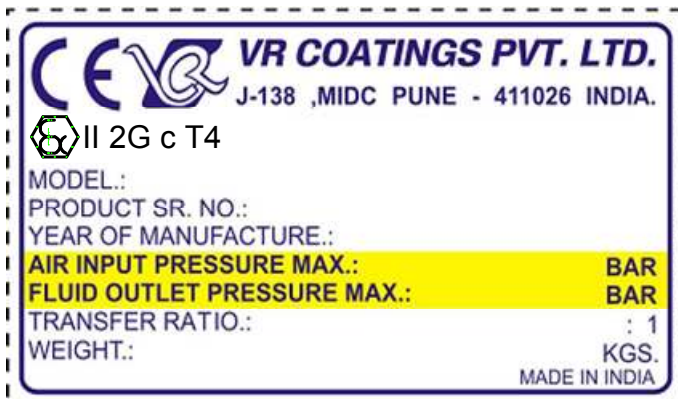

Name Plate



TECHNICAL SERVICE MANUAL

(Technischer service-handbuch)

Auto On/Off valves.



Serial Number:

VR COATINGS PVT.LTD

OFFICE: J-138, BHOSARI INDUSTRIAL AREA,PUNE MAHARASHTRA
INDIA-411026

WORKS:PLOT NO -136,SECTOR 7,PCNDTA BHOSARI,PUNE ,MAHARASHTRA
INDIA-411026

CONTACT US : sales@vrcoatings.com, www.vrcoatings.com, service@vrcoatings.com,

+91-20-8237086924, / 27130331 / 8237086903
Mr. Pascal Dsouza (Technical Director)
+91-9822655891



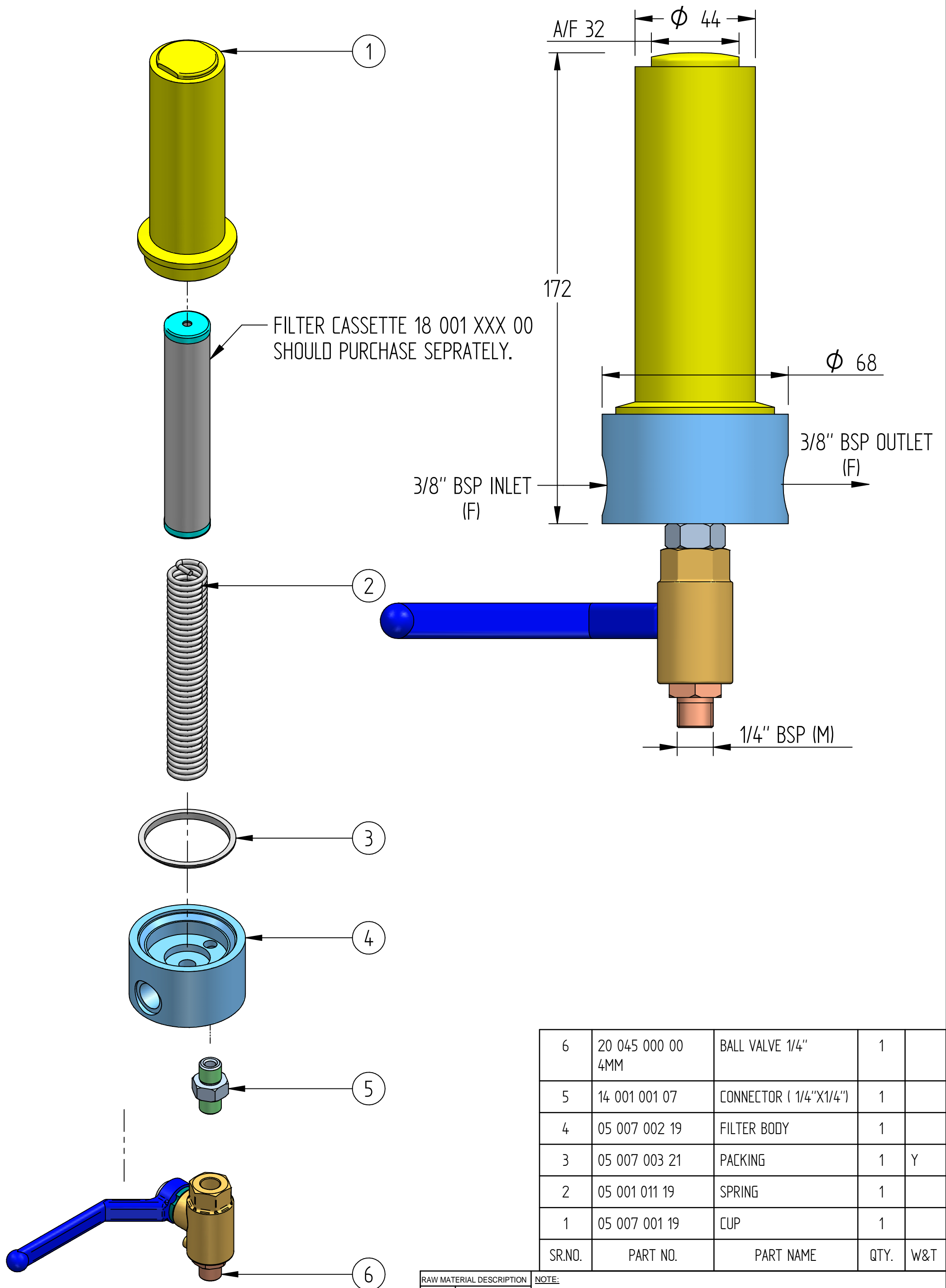

6	20 045 000 00 4MM	BALL VALVE 1/4"	1	
5	14 001 001 07	CONNECTOR (1/4"X1/4")	1	
4	05 007 002 19	FILTER BODY	1	
3	05 007 003 21	PACKING	1	Y
2	05 001 011 19	SPRING	1	
1	05 007 001 19	CUP	1	
SR.NO.	PART NO.	PART NAME	QTY.	W&T

RAW MATERIAL DESCRIPTION		NOTE:				
SIZE		ALL DIMN. ARE IN MM UNLESS OTHERWISE STATED. FOR OPEN TOLERANCE AND SURFACE ROUGHNESS SEE STANDARD CHART DD-01/CH-01. REMOVE SHARP CORNERS. INCASE OF DOUBT ASK.				
LENGTH						
MAT.						
VR COATINGS PVT.LTD. J-138, MIDC, BHOSARI, PUNE-411 026 INDIA		DRN.	CKD.	APPD.	PART NAME	LOW PRESSURE FILTER 3/8'
		SIGN	OMKAR		PART NO.	05 007 000 07
		DATE			SCALE	NOT TO SCALE

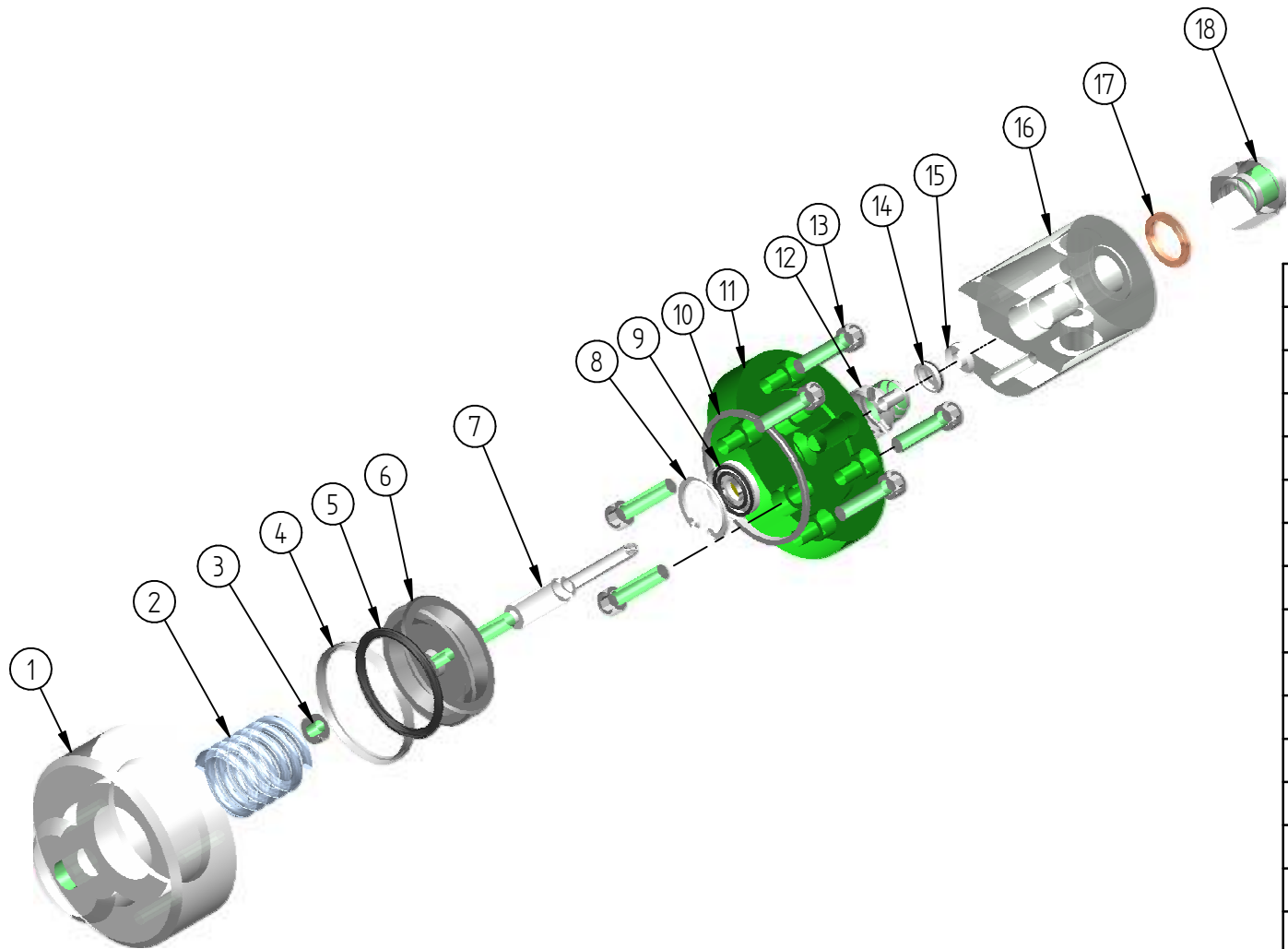

18	SEAT ASSEMBLY	06 024 001 00	1	
17	WASHER 3/8"	06 024 002 04	1	
16	BODY	06 024 015 19	1	
15	PACKING WASHER	06 024 004 19	1	
14	NEEDLE PACKING SET	06 024 005 00	1	Y
13	ALLEN BOLT M6X25	15 325 008 19	6	
12	PACKING NUT	06 024 006 03	1	
11	MIDDLE FLANGE	06 024 007 01	1	
10	SEALING RING	06 024 008 21	1	Y
9	AIR SEAL ASSEMBLY	06 024 014 00	1	Y
8	CIRCLIP B24	06 024 019 07	1	
7	NEEDLE ASSEMBLY	06 024 003 00	1	
6	DISC	06 024 010 01	1	
5	O RING(ID39XCS 3.5)	01 230 038 25	1	Y
4	PACKING RING	06 024 009 21	1	Y
3	NUT (M6X1)	15 205 008 19	1	
2	SPRING	06 024 011 30	1	
1	SPRING HOUSING	06 024 012 01	1	
S.NO	PART NUMBER	PART NAME	QTY	W&T

RAW MATERIAL DESCRIPTION		NOTE:	
SIZE			
LENGTH			
MAT.			
ALL DIMN. ARE IN MM UNLESS OTHERWISE STATED. FOR OPEN TOLERANCE AND SURFACE ROUGHNESS SEE STANDARD CHART DD-01/CH-01. REMOVE SHARP CORNERS. INCASE OF DOUBT ASK.			
		DRN.	CKD.
		APPD.	
 VR COATINGS PVT.LTD. J-138, MIDC, BHOSARI, PUNE-411 026 INDIA		SIGN	omkar
		DATE	
		SCALE	NOT TO SCALE
		PART NAME	AUTO. ON/OFF VALVE 3/8"
		PART NO.	06 024 000 00

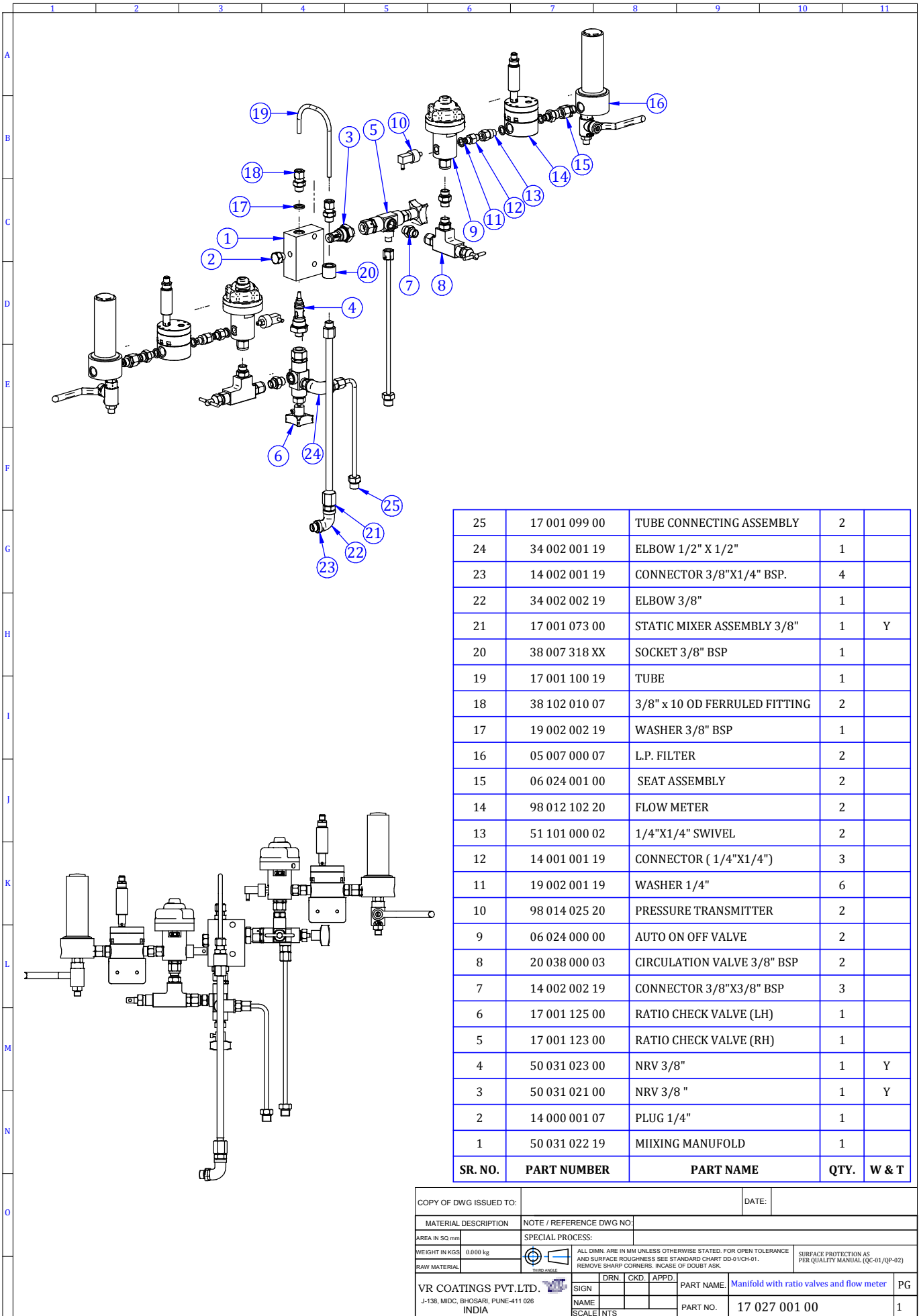

25	17 001 099 00	TUBE CONNECTING ASSEMBLY	2	
24	34 002 001 19	ELBOW 1/2" X 1/2"	1	
23	14 002 001 19	CONNECTOR 3/8"X1/4" BSP.	4	
22	34 002 002 19	ELBOW 3/8"	1	
21	17 001 073 00	STATIC MIXER ASSEMBLY 3/8"	1	Y
20	38 007 318 XX	SOCKET 3/8" BSP	1	
19	17 001 100 19	TUBE	1	
18	38 102 010 07	3/8" x 10 OD FERRULED FITTING	2	
17	19 002 002 19	WASHER 3/8" BSP	1	
16	05 007 000 07	L.P. FILTER	2	
15	06 024 001 00	SEAT ASSEMBLY	2	
14	98 012 102 20	FLOW METER	2	
13	51 101 000 02	1/4"X1/4" SWIVEL	2	
12	14 001 001 19	CONNECTOR (1/4"X1/4")	3	
11	19 002 001 19	WASHER 1/4"	6	
10	98 014 025 20	PRESSURE TRANSMITTER	2	
9	06 024 000 00	AUTO ON OFF VALVE	2	
8	20 038 000 03	CIRCULATION VALVE 3/8" BSP	2	
7	14 002 002 19	CONNECTOR 3/8"X3/8" BSP	3	
6	17 001 125 00	RATIO CHECK VALVE (LH)	1	
5	17 001 123 00	RATIO CHECK VALVE (RH)	1	
4	50 031 023 00	NRV 3/8"	1	Y
3	50 031 021 00	NRV 3/8 "	1	Y
2	14 000 001 07	PLUG 1/4"	1	
1	50 031 022 19	MIIXING MANUFOLD	1	
SR. NO.	PART NUMBER	PART NAME	QTY.	W & T

COPY OF DWG ISSUED TO:		DATE:	
MATERIAL DESCRIPTION		NOTE / REFERENCE DWG NO:	
AREA IN SQ mm	SPECIAL PROCESS:		
WEIGHT IN KGS	ALL DIMS. ARE IN MM UNLESS OTHERWISE STATED. FOR OPEN TOLERANCE AND SURFACE ROUGHNESS SEE STANDARD CHART DD-01/CH-01. REMOVE SHARP CORNERS. IN CASE OF DOUBT ASK.		SURFACE PROTECTION AS PER QUALITY MANUAL (QC-01/QP-02)
RAW MATERIAL	THIRD ANGLE		
VR COATINGS PVT. LTD. J-138, MIDC, BHOSARI, PUNE-411 026 INDIA		SIGN	PART NAME. Manifold with ratio valves and flow meter PG
		NAME	PART NO. 17 027 001 00
		SCALE NTS	1



TECHNICAL SERVICE MANUAL

(Technischer service-handbuch)

Colour Change Valve.

COLOUR CHANGE VALVE

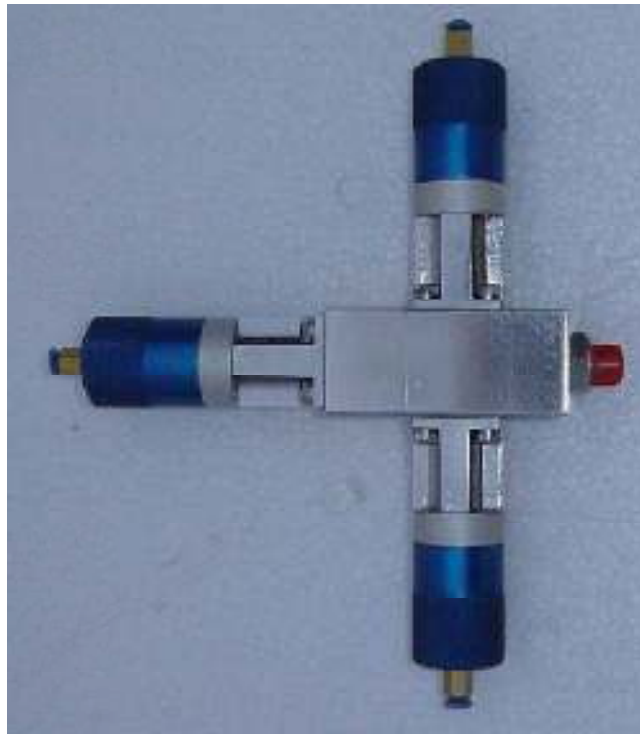

Serial Number:

VR COATINGS PVT.LTD

OFFICE: J-138, BHOSARI INDUSTRIAL AREA,PUNE MAHARASHTRA
INDIA-411026

WORKS:PLOT NO -136,SECTOR 7,PCNDTA BHOSARI,PUNE ,MAHARASHTRA
INDIA-411026

CONTACT US : sales@vrcoatings.com, www.vrcoatings.com, service@vrcoatings.com,

+91-20-8237086924, / 27130331 / 8237086903

Mr. Pascal Dsouza (Technical Director)

+91-982265589



OPERATING INSTRUCTIONS
for flow meters of the product line
„VS in Standard Version“



Table of Contents

	Page
Function description flow meter	4
General description	4
Flow meter selection	4
Declaration of Conformity	4
General conditions for initial start-up	4
Maximum operating pressure	5
Flow meter range	5
Assembly of the flow meter	6
Cleaning and flushing of pipe lines before initial start-up	7
Filtering of liquid	7
Pre-amplifier	7
Maintenance	9
Sending back of repairs and sample devices	9
Technical specifications VS 0.02 - VS 4	10
Flow response curves VS 0.02 - VS 4	11
Dimensions VS 0.02 - VS 4	12
Dimensions, subplate AP.02 - 4	13
Technical specifications VS 10	14
Flow response curves VS 10	14
Dimensions VS 10	15
Dimensions, subplate APG 10	15
Type key	16
Pre-amplifier - block wiring diagram	17
Output signals on pre-amplifier	17
Plug assignment	18
Connection diagram	18
Pick-up system for high temperatures HT	18

• General function description of flow meter

Flow meters made by VSE Volutentechnik GmbH measure the volume flow of liquids according to the toothed wheel principle. A pair of very precisely adjusted toothed wheels in the housing constitutes the meter. A signal pick-up system registers meter rotation free of contact and tooth by tooth. Each tooth is output as digital pulse.

The gaps in the teeth of the meter wheels form meter chambers in the areas

in which they are completely enclosed by the housing walls; these chambers digitalise liquid flow depending on their chamber volume.

The liquid flow quantity within one meter rotation of a tooth division forms the volume measurement per pulse (V_m) and is defined in cm^3/pulse . It identifies the constructional size of a flow meter.

• General description

Please observe all instructions in this operating manual; only this guarantees a trouble-free operation of the flow meters. VSE is not liable for any damage ensuing from non-observation of these instructions.

Opening the devices during the term of guarantee is only authorised after consultation and approval of VSE.

• Flow meter selection

The correct selection (version) of type and constructional size is crucial for a trouble-free and safe operation of the flow meters. Owing to the great number of various applications and flow meter versions, the technical specifications in the VSE catalogue material are of

a general nature. Performance of the flow meter depends on type, size and meter range and on the liquid that is to be measured. Please consult VSE for an exact description.

• Declaration of Conformity

Flow meters of the "VS" product line are tested for their electromagnetic compatibility and interference transmission in terms of the law on electromagnetic compatibility and correspond to the legal prescriptions enforced by EMC directives. They may not be operated independently and are to be connected via cable to a power source and supply digital electric signals for electronic evaluation. A declaration of conformity is submitted for all flow meters, which you can request if you require.

Since the electromagnetic compatibility of the total measuring system depends as well on cable layout, correct connection of protective

shielding and each single connected device, you must ensure that all components correspond to the electromagnetic compatibility directives and that the electromagnetic compatibility of the total system, machine or plant is guaranteed.

All flow meters are tested according to the valid, legally prescribed electromagnetic compatibility directives EN 55011 and EN 61000 and possess the CE certification. The EC declaration of conformity is the CE label attached to all flow meters.

• General conditions for initial start-up

Before assembly and before initial start-up, you have to note the following properties and aspects of the corresponding characteristics of your system, so that a trouble-free and safe operation is possible.

1. The process fluid

- Is the flow meter **suitable for the fluid**?
- Is the fluid **viscous or abrasive**?
- Is the fluid **contaminated** or is there **solid matter in the fluid**?
- Which **granular size** does the solid matter possess and can it **block the meter**?
- Does the fluid have **fillers** or other **additional material**?
- Is it necessary to install a pre-switched **hydraulic filter**?
- Are the **pipe lines clean** and free of assembly residues such as swarf, weld chips?
- Is the **tank clean** and is it ensured that **no extraneous materials** can get into the pipe-line system from the tank?
- Is the fluid often changed and is **sufficient flushing performed in this case**?
- Are the pipe lines and the entire system completely **de-aerated**?
- What **cleaning agent** is being used?
- Are the fluid and the cleaning agent compatible with the **seals**?
- Are the **seals suitable** for the fluid undergoing measurement (**seal compatibility**)?

2. The hydraulic properties of the system

- Is the **max. operating pressure of the system** lower than the max. permitted operating pressure of the flow meter?
- Is the **max. fall of pressure Δp** (on flow meter) below the max. permitted fall of pressure?
- Does an excessively **great fall in pressure Δp** occur on the flow meter at max. flow (e.g. with higher viscosity)?
- Does the flow range of the flow meter (depending on viscosity) correspond to the **provided flow**?
- Note that flow range decreases the **greater the viscosity!**
- Does the temperature range of the flow meter correspond to the **provided max. temperature** of the medium?
- Is the **cross section** of the pipe line large enough and are the falls in pressure in the system not excessive?
- Is the **hydraulic connection** (supply and reverse flow) correctly connected and leak-proof?
- Has the **pump** sufficient power to operate the system?
- A blocking flow meter can stop the whole flow. Is a **pressure control valve / bypass** provided in the system?

3. Electronic evaluation and electrical safety

- Have you selected the optimal flow meter and is this equipped with the **appropriate pre-amplifier**?
- Does the **power supply voltage** of the flow meter correspond to the provided voltage?
- Is the power supply voltage supplied by the mains or evaluation device sufficiently **steady**?
- Does the **output** of the power supply voltage correspond to the required power output?
- Has the electric connection been installed based on the enclosed **connection plan**?
- Is the **cable protective shielding** correctly connected on both sides on the earth conductor PE?
- Is there a **potential difference** between the earth conductor connection PE on the flow meter and the earth conductor PE on the evaluation device?
- Does a correcting lead have to be laid to eliminate the **potential difference** between the flow meter and the evaluation device?
- Is the flow meter connected firmly to the **earth conductor PE** (e.g. via the pipe lines)?
- Is the meter of the flow meter constructed to be **insulated** to the earth conductor PE (e.g. connection via hoses)? If this is the case, the meter has to be connected with the earth conductor PE!
- Is there a **continuous connection** of the cable protective shielding (earth conductor PE) via the housing, of the 4-pin round plug to the meter of the flow meter?
- Is the cable laid fault-free and the installation secured from input of **interference pulses**?
- Is the **4-pin round plug** of the connection cable firmly screwed together with the plug of the flow meter?
- Are the wires on the **evaluation device** correctly and properly connected?
- Does the entire system correspond to the directives of the electro-magnetic compatibility laws (**EMC**)?
- Have all local valid regulations, **applicable directives**, guidelines and background conditions of the **electro-magnetic compatibility laws** been maintained and observed?
- Systems that can lead to personal injury through malfunction or failure are to be equipped with the **appropriate safety devices**. The functioning of these safety devices is to be checked at regular intervals.

• Maximum operating pressure

Before assembling the flow meter, you have to test that the max. operating pressure of the system does not exceed the max. permitted operating pressure of the flow meter. Meanwhile, observe the top pressures that can occur when operating the system.

The following operating pressures are permitted depending on flow meter version:

- Flow meter in grey cast iron version $p_{max} = 315 \text{ bar}$
- Flow meter in stainless steel version $p_{max} = 450 \text{ bar}$
- Flow meter in special version $p_{max} = \text{up to } 700 \text{ bar}$

Important:

Please consult VSE for all operating pressures > 450 bar and for special versions.



• Flow meter range

The flow meter range specified in the flow meter data sheet ($Q_{min} - Q_{max}$) refers to the testing fluid 'hydraulic oil' with a viscosity of $21 \text{ mm}^2/\text{s}$ at a temperature of $20 \text{ }^\circ\text{C}$. For this flow meter range, VSE specifies measurement accuracy of up to 0.3 % of the measurement value and a repetition accuracy of 0.05 %.

For fluids of lower viscosity ($< 21 \text{ mm}^2/\text{s}$) measurement accuracy deteriorates, while for fluids of higher viscosity ($> 21 \text{ mm}^2/\text{s}$) it can improve. Also note, however, that the flow meter range is restricted in case of higher viscosity (see flow meter data sheet).



Important:
Make sure that the specified maximum permitted operating pressure of the flow meter cannot be exceeded, whatever the operating mode of the system. Note the flow meter range that is dependent on the viscosity of the fluid to be measured.

• **Assembly of the flow meter**

The flow meter should be mounted on an easily accessible location, so that dismantling for cleaning the meter presents no problem. Since flow meters can work in any installation position and flow direction, you can mount it on any location of your system that you wish. Take care when installing the flow meter that liquid always remains in the flow meter even at system standstill and that it can never run empty. The outflow of the flow meter should therefore always show a certain back pressure. In critical cases or when the pipe line is at standstill or standby and can run empty, we recommend installing an extra non-return valve in the outflow line.

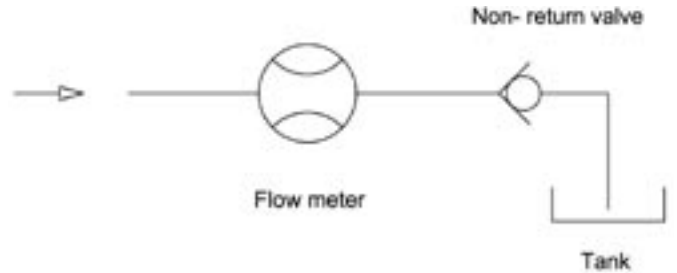

Fig. 1: Flow meter installation with non-return valve



Important:
Make sure that the flow meter is always completely filled both in inflow and outflow and that the outflow has a little back pressure. This prevents the meter being damaged by a sudden and steep increase of flow and at the same time improves measurement accuracy.

Flow meters of the “VS” product line can be mounted directly onto a block or into the pipe line using four screws. Always select large cross sections for the hydraulic supply and return flow respectively for the entire pipe-line system (if possible). This lowers the fall in pressure and the flow rate in the total system.

Block assembly:

The flow meter is directly mounted onto a subplate or manifold, extra components are not needed. The block contains the hydraulic supply and outflow of the flow meter and the fixing bore holes (see flow meter dimension sheet).

VSE supplies subplates for all flow meters of the “VS” product line; they have various pipe threads and side or rear-side connection (see subplates data sheet). Depending on the provided conditions, the installed pipe line, the pipe cross section or pipe thread, the operator can choose the suitable subplate and incorporate this into the system or machine without additional reductions.

Table 1: Torque of fastening screws

Flow meter, size (cast iron and 1.4305)	Torque
VS 0.02; VS 0.04; VS 0.1; VS 0.2	40 Nm
VS 0.4; VS 1; VS 2	70 Nm
VS 4	120 Nm
VS 10	280 Nm

The flow meter is screwed onto the block or subplate with four DIN 912 cheese head screws. The screws are to be evenly pre-tensed crosswise with the following torques.

Please note the special instructions for mounting sizes VS 4 and VS 10 (see appendix)

When changing the fastening screws you must take great care that the screws are of property class 10.9 and 12.9.

Important:

When mounting the flow meter, you must take great care that the seals are not damaged and correctly placed in the hydraulic connections of the flow meter. Wrongly installed or damaged seals lead to leakage and to an leaky system, which may have dire consequences. Please make sure that flow meters with EPDM seals do not come into contact with oil and greases on a mineral oil basis. These fluids can decompose the seals. The yellow plastic plugs in the hydraulic connections of the flow meter protect the meter against dirt and contamination during storage and shipping. Before mounting the flow meter you have to remove these plugs so that in- and outflow is free and open.



• **Cleaning and flushing of pipe lines before initial start-up**

Before initial start-up of the flow meter, you must flush and clean the whole system. Contaminated fluids can affect the correct function of the flow meter or seriously damage the meter.

After preparing and connecting up the system pipes, you must first carefully flush and clean the whole pipe-line system and the tank. To do this, you have to mount a diversion plate onto the block or connection plate instead of the flow meter, so that the fluid can flow through the diversion plate and all extraneous material (e.g. swarf, metal chips, etc.) can be flushed out without obstruction. Use a fluid as cleansing agent which is compatible with the fluid being used later and which does not cause undesirable reactions. You can consult the suppliers and manufacturers of the fluid or

contact VSE for the corresponding information. VSE supplies bypass-plates the corresponding for all VS-flow meter sizes.

Flow meters are measurement pick-up systems made with high-level precision. They have a mechanical meter consisting of two toothed wheels and which is adapted to the housing with narrow slots. Even the tiniest damage to the toothed wheels and bearings can cause a measurement error. So always make sure that no extraneous material gets into the meter and that the fluid flowing through is always free from dirt and contamination.

After the system has been carefully flushed out and no extraneous material is in the pipe line, you can mount the flow meter and commence the initial start-up.

Important:

Please flush out the pipe lines and the tank thoroughly, to prevent contamination with the flow meter.



• **Filtering of liquid**

Strongly contaminated fluid or extraneous material in the fluid can block, damage or even destroy the flow meter. Always install a sufficiently large filter for these cases in front of the flow meter to prevent damage to the flow meter. The necessary filtering depends on size, storage and model of flow meter.

Table 2: Pre-switched filters

Flow meter size	Filter size for ball bearings
VS 0.02 / 0.04 / 0.1	10 µm
VS 0.2 / 0.4	20 µm
VS 1 / 2 / 4 / 10	50 µm

For information on filter size for flow meters with plain bearings, in special version, or with specially adjusted meter tolerances, please consult **VSE GmbH**.

Important:

A blocking flow meter can stop the whole flow. You have to provide a control valve / bypass for the system.



• **Pre-amplifier**

The pre-amplifier for the standard version is short-circuit-proof, reverse-polarity-proof and processes the signals of the scan sensors. A high level of interference protection is achieved through the push-pull output stages of the pre-amplifier. You can easily connect evaluation devices with both PNP

and NPN inputs to the outputs. The two-channel output of digital signals enables a higher measurement resolution and also a direction recognition of the flow.

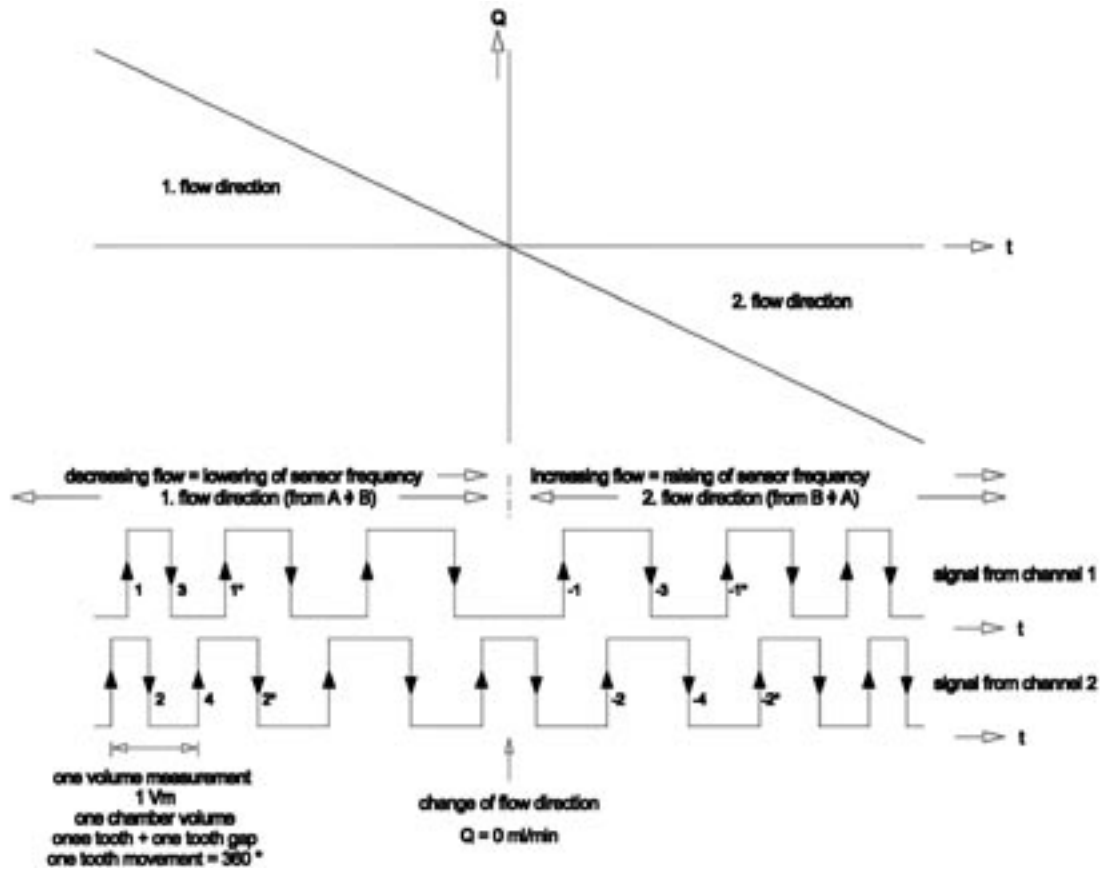



Fig. 2: Signal output of pre-amplifier

Power supply voltage in voltage range $U_b = 10... 28$ VDC. You can operate the pre-amplifier with any voltage in this voltage range U_b , but make sure that the signal voltage is always adjusted to the power supply voltage and

that the output signal has a signal level of $U_{sig} = U_b - 1V$. Permitted for the power supply is a steady direct voltage with a maximum residual ripple of $\pm 15\%$.

Important:
Please make sure that no extra inductive elements are connected in the power supply of the flow meter, such as contactors, relays, valves, etc. These components are potent sources of interference (especially if the inductive elements are not provided with an adequate protective circuit), generate high interference pulses when switched and can interfere with the functioning of the flow meter, although this complies with the electromagnetic compatibility directives.



The no-load current reception of the pre-amplifier depends on each power supply voltage.

Power supply voltage $U_b = 12$ VDC	$I_{0max12} = 25$ mA
Power supply voltage $U_b = 24$ VDC	$I_{0max24} = 40$ mA
Max. current per channel	$I_{Kmax} = 20$ mA

(the current I_k is dependent on the input impedance of the evaluation electronics)

Total current reception (at 12 VDC)	$I_{0tot.} = 65$ mA
$I_{0tot.} = I_{0max12} + (2 \times I_{Kmax})$	$P_{max} = 0.78$ W

Total current reception (at 24 VDC)	$I_{0tot.} = 80$ mA
$I_{0tot.} = I_{0max24} + (2 \times I_{Kmax})$	$P_{max} = 1.92$ W

The electric connection of the flow meter is performed via the 4-pin round plug located on the pre-amplifier housing. The connection cable plug is plugged into the plug connection of the flow meter and screwed together with it.

Important:

Only use well-shielded cables for the connection cable, with a wire cross section of $\geq 4 \times 0.25 \text{ mm}^2$. Please make sure that the housing of the round plug is metallic, that it has a connection for the shielding and that the potential of the earth conductor PE is connected to the cable shielding and the housing of the pre-amplifier



The shielding of the connection cable is placed on both sides. The earth conductor PE is connected via the shielding from the evaluation electronics to the pre-amplifier housing and the meter. The cable shielding should always be laid continuously as far as the flow meter and not interrupted in cross connectors or branch sockets. Lay the connection cable as directly as possible from the evaluating device to the flow meter, since interruptions are always a potential source of error.

The flow meter must be connected electrically with the earth conductor PE. This is normally secured by the earthed pipe lines.

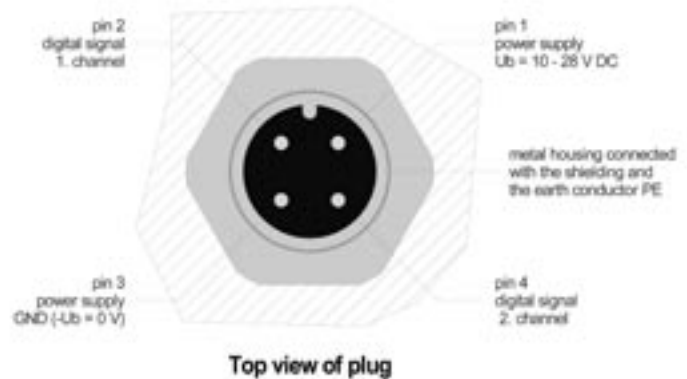

Fig. 3: M12 plug connector installed in the pre-amplifier housing of the flow meter

Important:

If there are potential differences between the pre-amplifier housing and the earth conductor PE of the evaluating electronics, you have to lay a correcting earth (see connection diagram).



The maximum cable length between flow meter and the evaluation electronics is approx. 120 m. With extensive cable lengths (as of approx. 40 m) you must take care that the connecting cable is laid in an interference-free

environment, that the shielding is connected on both sides of the earth conductor PE and that there is no potential difference between the two earth conductor connections.

• Maintenance

Working life is dependent on operating conditions and thus the specific properties of the devices, limited through wear, corrosion, deposits or age.

The operator is responsible for regular control, maintenance and recalibration. Any indication of a malfunction or damage prohibits any further use. On request, we can supply you with a borrowed device for the duration of repair or overhauling.



• Sending back of repairs and sample devices

It is imperative that you enclose an exact description of the complaint, objection or fault when returning the device so as to ensure a rapid and economic repair of the flow meters and other components. Furthermore, you must include a security sheet, which informs unambiguously which fluid was run with the flow meter and how dangerous this fluid is.

The maintenance of legal regulations as regards work safety, such as workplace regulations, accident prevention regulations, and stipulations on environmental protection, waste disposal and the water management law, obliges industrial corporations to protect their employees and other persons and environment against harmful effects when handling hazardous

materials. If further safety precautions are still necessary despite careful emptying and cleaning of the flow meter, information on this is imperative and must be included with the returned despatch.

When returning flow meters to VSE Volumentechnik GmbH, please note that inspection and repair will only be performed if the **safety specifications sheet** of the utilised medium is enclosed and the flow meters completely cleaned and flushed. This protects our employees and simplifies our work.

If this is not observed, the despatch will be returned, chargeable to the recipient.

• **Technical specifications VS 0.02 – V S4**

Size	Measuring range l/min	Frequency Hz	Pulse value cm ³ /pulse	R-factor pulse/litre
VS 0.02	0.002 ... 2	1.667 ... 1666.67	0.02	50 000
VS 0.04	0.004 ... 4	1.667 ... 1666.67	0.04	25 000
VS 0.1	0.01 ... 10	1.667 ... 1666.67	0.1	10 000
VS 0.2	0.02 ... 18	1.667 ... 1500.00	0.2	5 000
VS 0.4	0.03 ... 40	1.250 ... 1666.67	0.4	2 500
VS 1	0.05 ... 80	0.833 ... 1333.33	1	1 000
VS 2	0.1 ... 120	0.833 ... 1000.00	2	500
VS 4	1.0 ... 250	4,167 ... 1041.67	4	250

Measurement accuracy	: up to 0.3 % of measurement value (with viscosity > 20mm ² /s)
Repetition accuracy	: ± 0.05 % under the same operating conditions
Material	: Cast iron EN-GJS-400-15 (EN 1563) or stainless steel 1.4305
Meter bearing	: Ball bearings or steel plain bearings (medium-dependent)
Seals	: FPM (standard), NBR, PTFE or EPDM
Max. operating pressure	: Cast iron EN-GJS-400-15 (EN 1563) 315 bar stainless steel 1.4305 450 bar
Medium temperature	: -40 ... + 120°C (-40 °F ... 248 °F)
Ambient temperature	: -20 ... + 50°C (-4 °F ... 122 °F)
Viscosity range	: 1 ... 100 000 mm ² /s
Installation position	: any
Flow direction	: any
Running noise	: max. 72 db(A)
Power supply version	: 10 to 28 volts/DC
Pulse output	: 2 x push-pull output stages reverse-polarity-proof, short-circuit-proof low signal: 0 = GND; high signal: 1 = U _b -1 I _{max} = 80 mA (at 24V) P _{max} = 1.92W (at 24V)
Channel offset	: 90° ± 30° max.
Pulse-width repetition rate	: 1/1 ± 15° max.
Pre-amplifier housing	: Aluminium
Protection type	: IP 65

• Flow response curves VS 0.02 – VS 4

VS 0.02

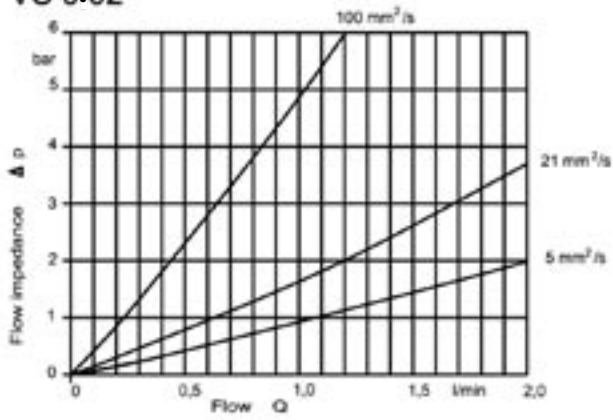

VS 0.04

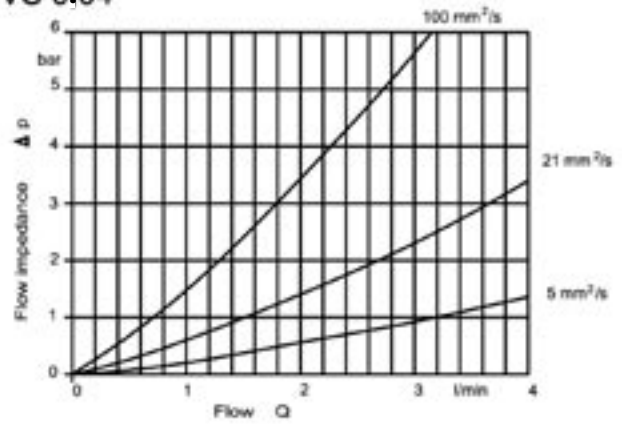

VS 0.1

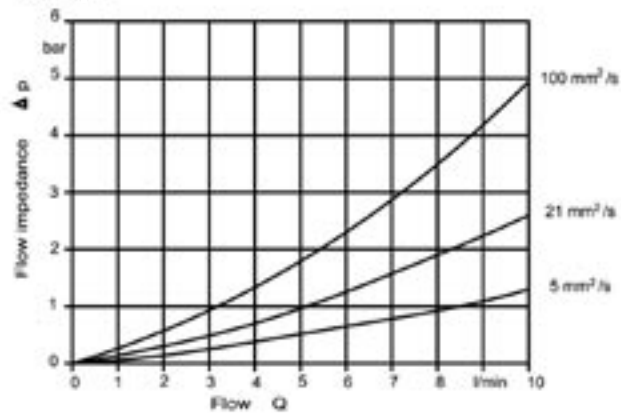

VS 0.2

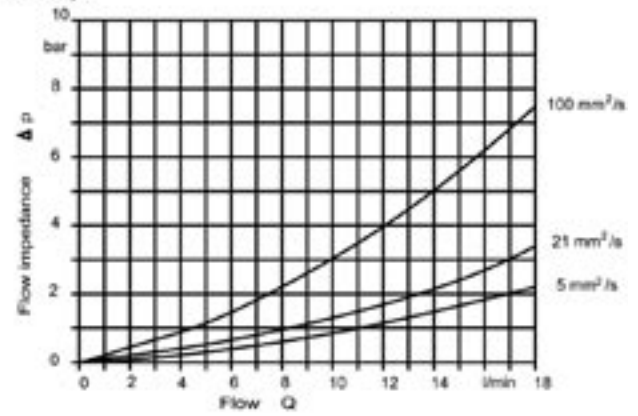

VS 0.4

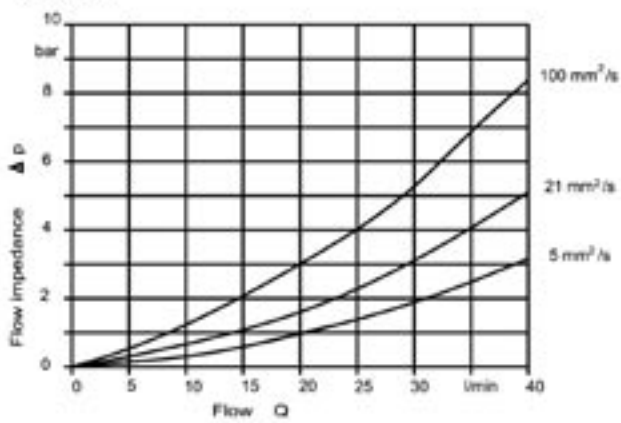

VS 1

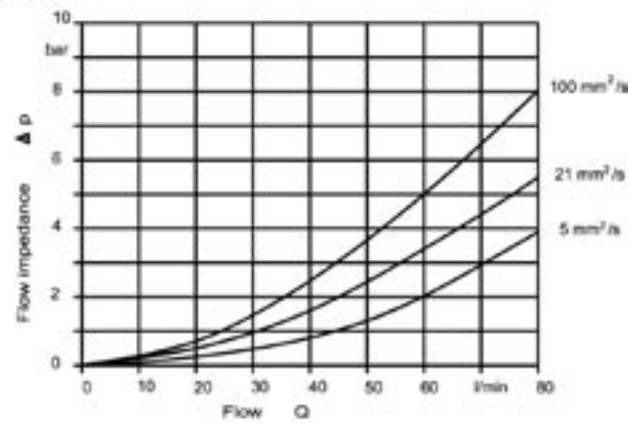

VS 2

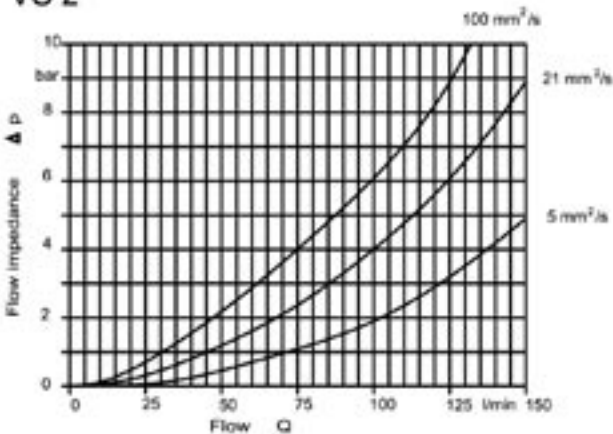

VS 4

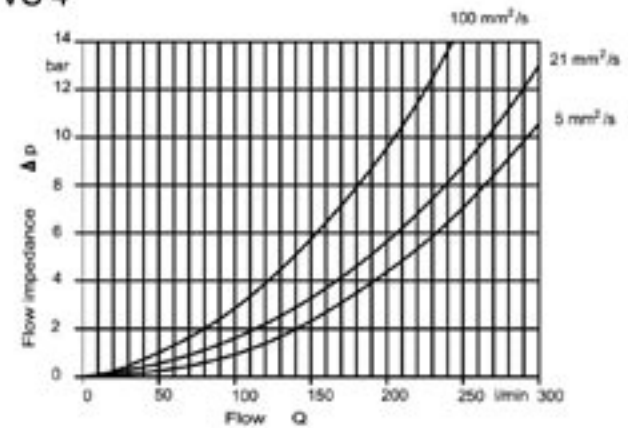

• Dimensions VS 0.02 – VS 4

Cast iron version

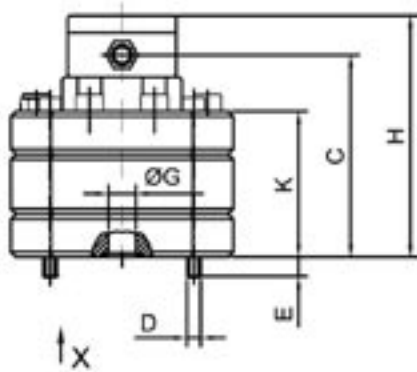

Stainless steel version
Connection diagram
Housing without milled edge

View X

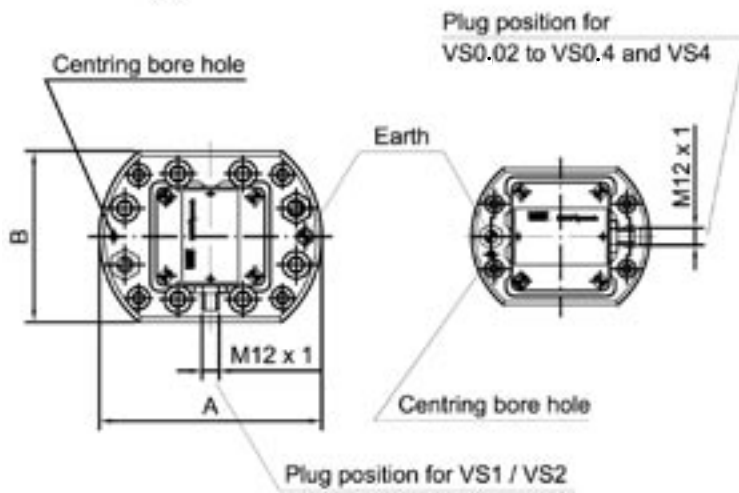
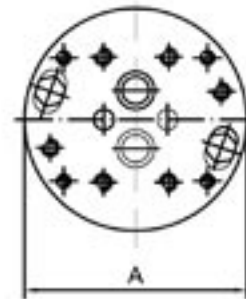

Cast iron version
Connection diagram

View X

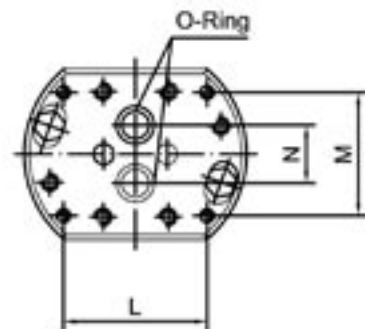

size VS	A	B	C	D	E	ØG	H	K	L	M	N	O-ring	Weight	
													GCI kg	SS kg
0.02	100	80	91	M6	12.0	9	114	58	70	40	20	11 x 2	2.8	3.4
0.04	100	80	92	M6	11.5	9	115	59	70	40	20	11 x 2	2.8	3.4
0.1	100	80	94	M6	9	9	117	61	70	40	20	11 x 2	2.8	3.4
0.2	100	80	94	M6	9.5	9	117	61	70	40	20	11 x 2	3.0	3.7
0.4	115	90	96.5	M8	11.5	16	120	63.5	80	38	34	17.96 x 2.62	4.0	5.0
1	130	100	101	M8	12.5	16	124	68	84	72	34	17.96 x 2.62	5.3	6.8
2	130	100	118	M8	15	16	141	85	84	72	34	17.96 x 2.62	6.7	8.4
4	180	140	145	M12	20	30	168	110	46	95	45	36.17 x 2.62	14.7	18.4

The dimensions are in mm

• Dimensions, subplates AP.02 - 4

Connection position, side

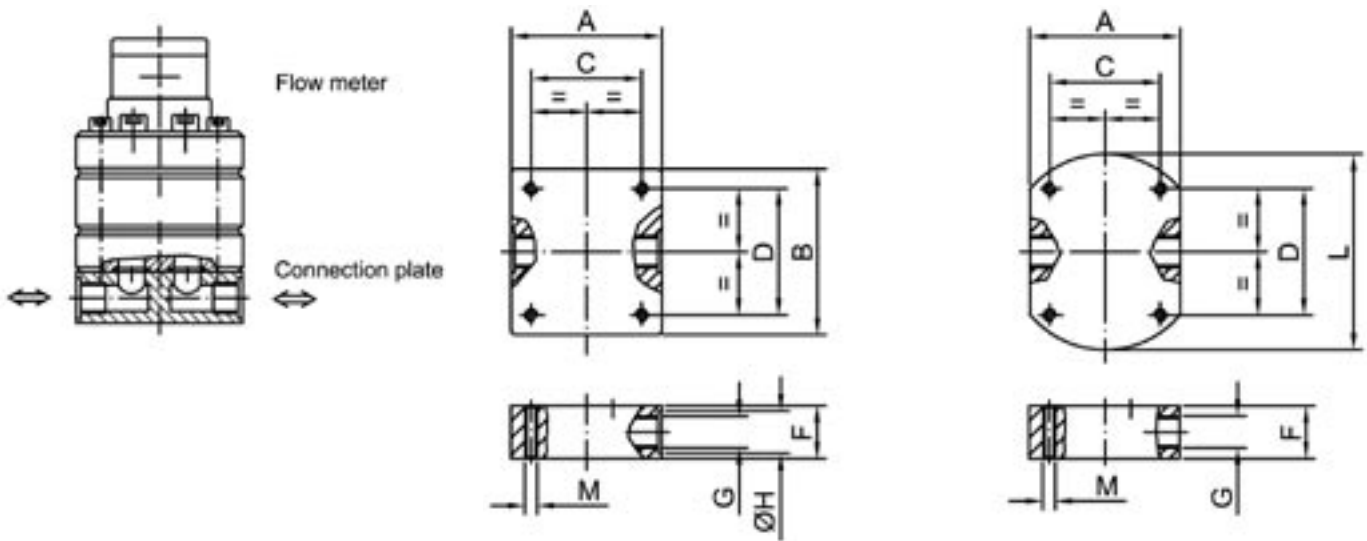

For size	Connection thread	F	øH	A	B	C	D	SS	L	Thread / depth	Weight
VS	G										
0.02	G 1/4"	"5	20	80	90	40	70	26	100	M6 / 12	1.8
0.04	G 3/8"		23					30			
0.1	G 1/2"		28					38			
0.2											
0.4	G 1/2"	35	28	90	100	38	80	46	115	M8 / 15	2.7
	G 3/4"	40	33					52			
1	G 1/2"	35	28	100	110	72	84	46	130	M8 / 15	3.6
2	G 3/4"	40	33					52			
	G 1"	55	41					55			
4	G 1 1/4"	70	51	120	130	100	110	60	180	M8 / 15	7.4
	*G 1 1/2"	70	56					120			
	G 1 1/2"	80		140			110				

only for AP . 4 U...

Connection position below

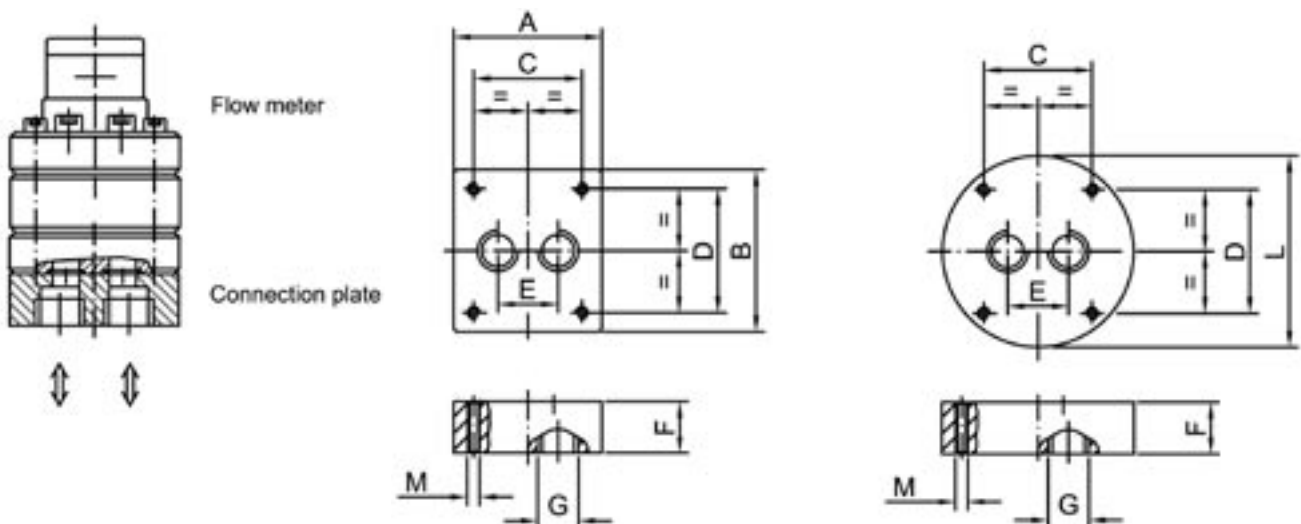

• Technical specifications VS 10

Size	Measuring range l/min	Frequency Hz	Pulse value cm ³ /pulse	R-factor pulse/litre
VS 10	1.5 ... 525	7.50 ... 2625.00	3.333	300

Measurement accuracy	: up to 0.5 % of measurement value (with viscosity > 20mm ² /s)
Repetition accuracy	: ± 0.05 % under the same operating conditions
Material	: Cast iron EN-GJS-600-3 (EN 1563)
Meter bearing	: Ball bearings or steel plain bearings (medium-dependent)
Weight	: 70 kg without connection plate
Seals	: FPM (standard), NBR, PTFE or EPDM
Max. operating pressure	: 350 bar / 5000psi
Medium temperature	: -40 °F ... 120 °F (-40 °F ... 248 °F)
Ambient temperature	: -20 ... + 50 °C (-4 °F ... 122 °F)
Viscosity range	: 5 100 000 mm ² /s
Installation position	: any
Flow direction	: any
Running noise	: db(A)
Power supply version	: 10 to 28 volts/DC
Frequency range	: 0 ... 2625 Hz
Pulse output	: 2 x push-pull output stages reverse-polarity-proof, short-circuit-proof low signal: 0 = GND; high signal: 1 = Ub - 1 I _{max} = 80 mA (at 24V) P _{max} = 1.92W (at 24V)
Channel offset	: 90° ± 30° max.
Pulse-width repetition rate	: 1/1 ± 15° max.
Pre-amplifier housing	: Aluminium
Protection type	: IP 65

• Flow response curves VS 10

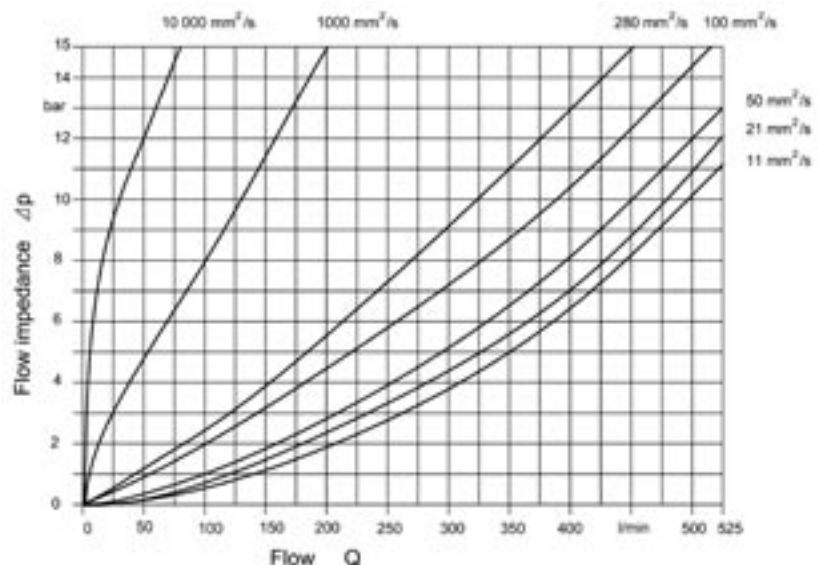

• **Dimensions VS 10**

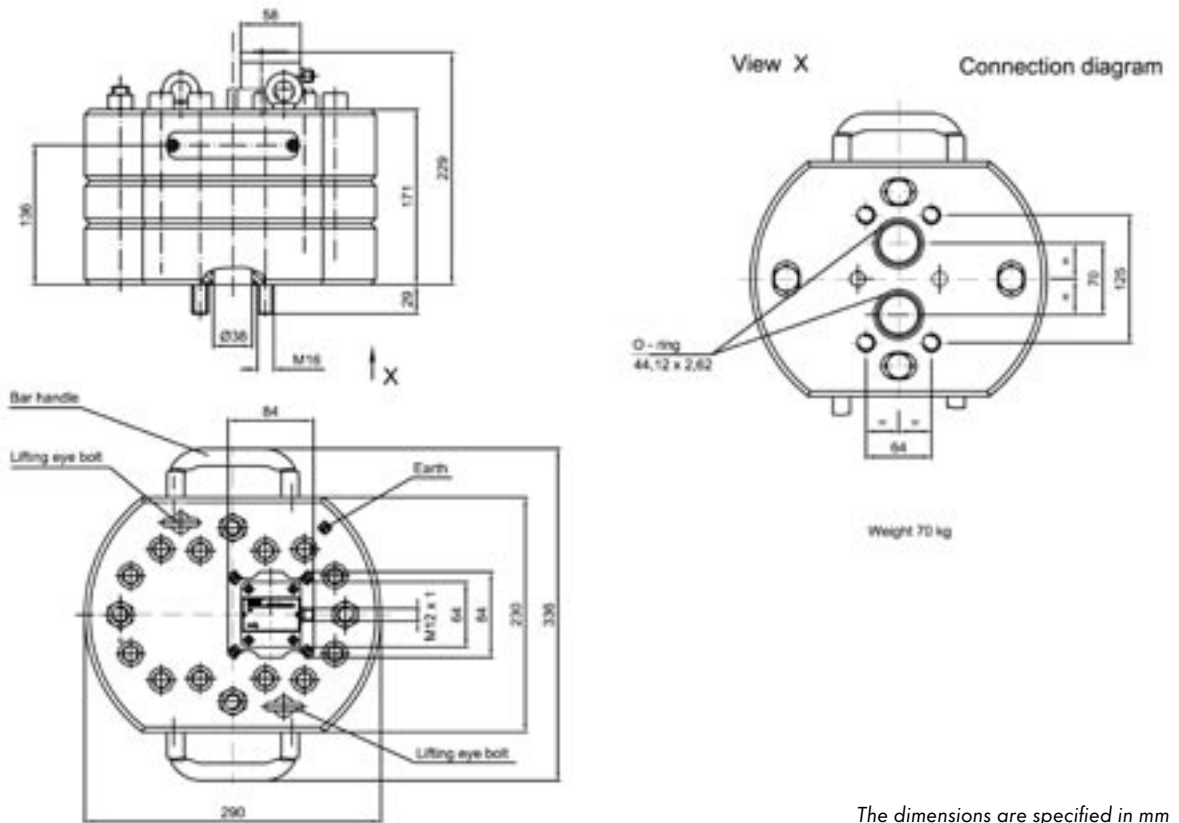

The dimensions are specified in mm

• **Dimensions, subplate APG 10.**

APG 10 SG0N / 1

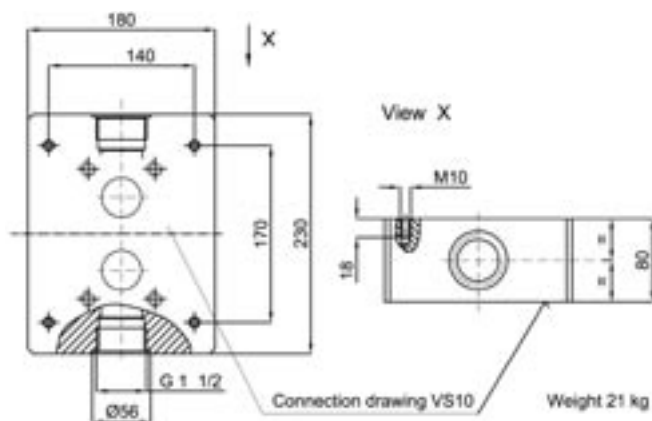

APG 10 SW0N / 1

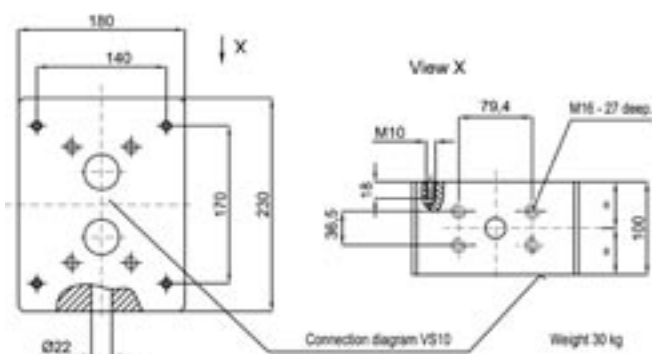

The dimensions are specified in mm

• Type key
Flow meters VS

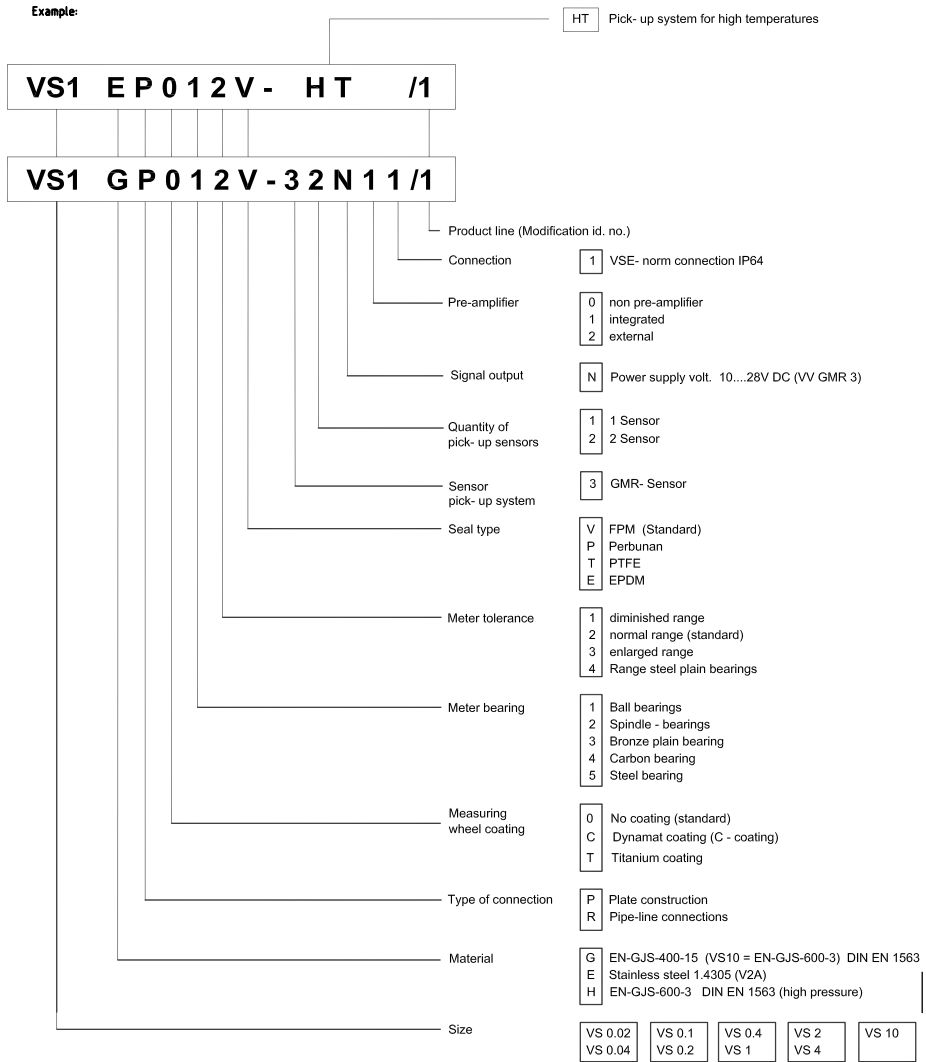

Subplates AP...

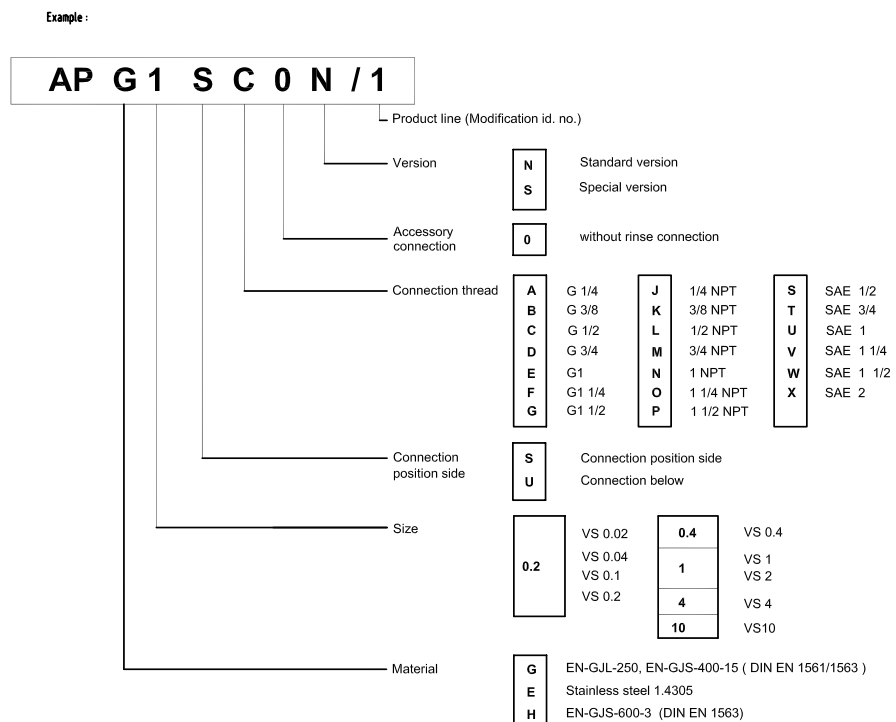

• Pre-amplifier - block wiring diagram

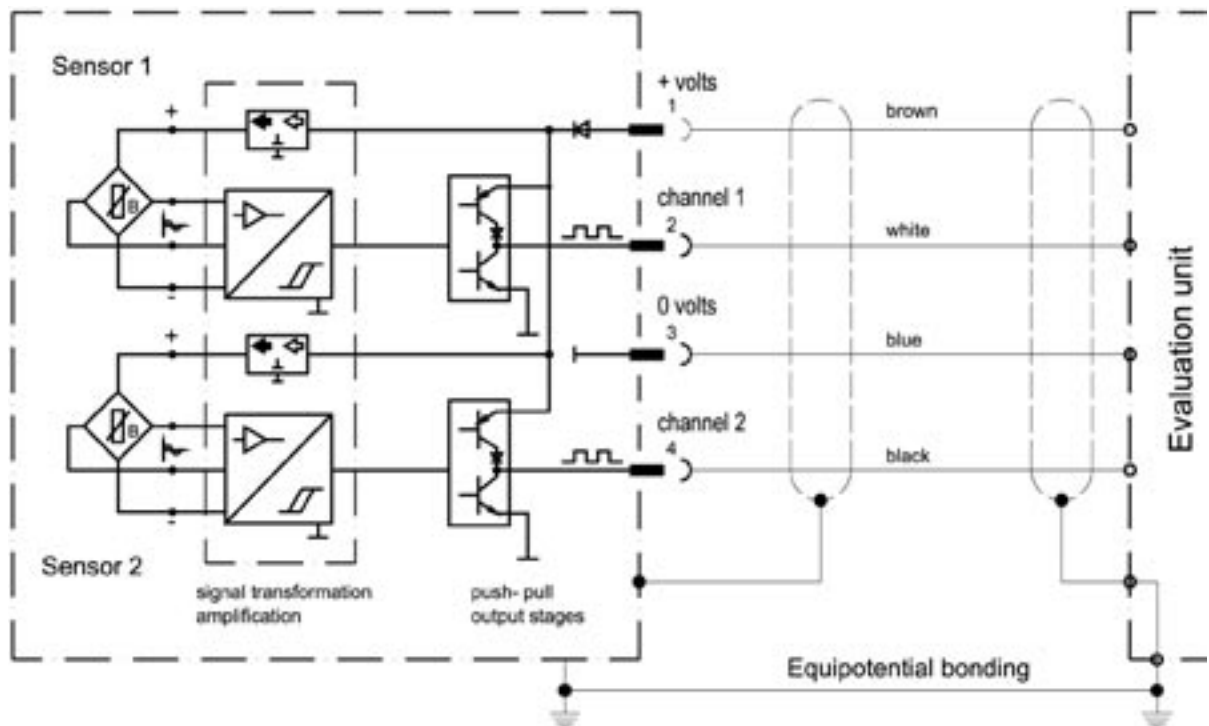

• Output signals on pre-amplifier

Flow meter VS 0.02VS 4

Flow meter VS10

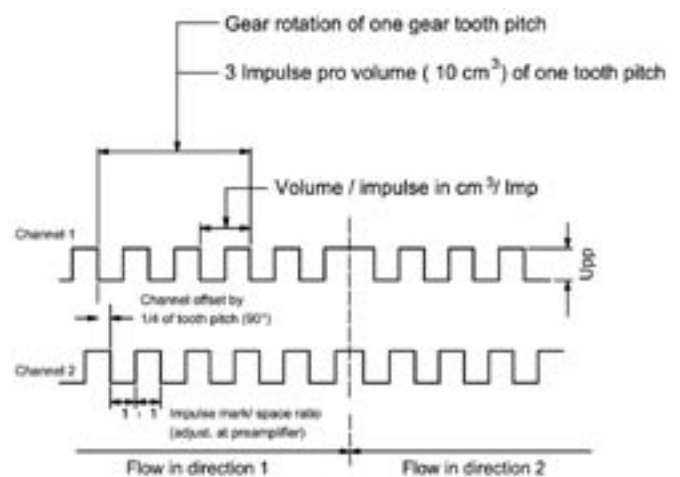
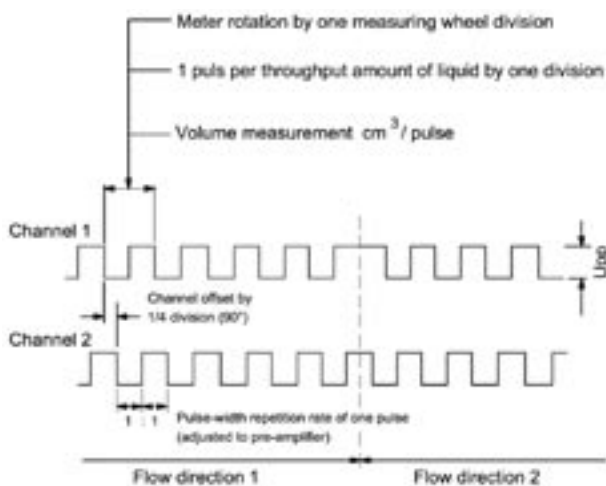

Voltage ranges

Power supply voltage: $U_V = 10 \dots 28 \text{ V DC}$
 Signal voltage: $U_{SS} = U_V - 1V$

• **Plug assignment**

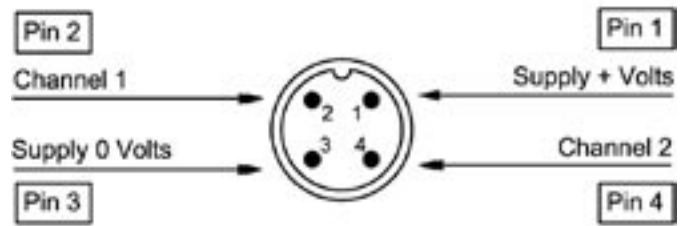
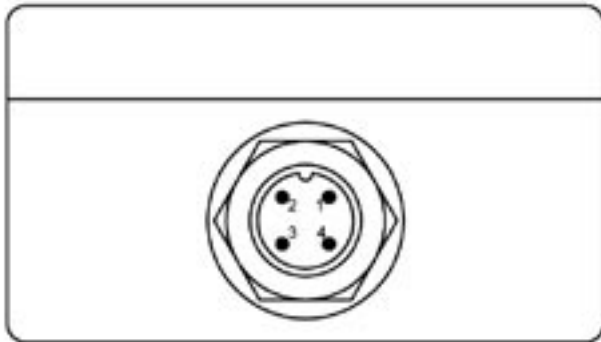

• **Connection diagram**

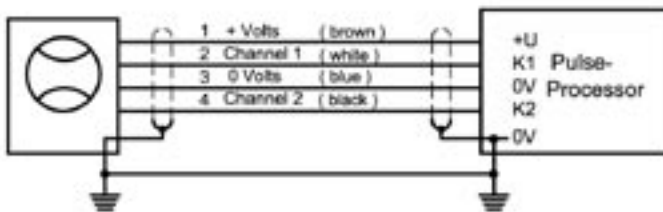

Modification of flow direction indicator
(+ after -) / - after +) by interchanging
channels
(channel 1 _ channel 2)

• **Pick-up system for high temperatures HT**

For medium temperatures >120°C, the high temperature (HT) versions by VSE have to be deployed. Flow meters of stain-less steel are used exclusively in this case.
The sensor or pick-up system consists of a sensor unit which is screwed into the cover of the flow meter and a downstream amplifier. The amplifier is connected with the flow meter via a temperature-stable cable and has to

be installed outside the high temperature zone. The ambient temperature should be no more than 50°C in this area.
The digital signals are emitted as PNP- or NPN- signals, depending on amplifier version.
With extensive cable lengths, we recommend using shielded cables and a pull-down (PNP signal) or pull-up impedance (NPN signal).

Plug assignment HT



Top view of plug

Connection diagrams HT

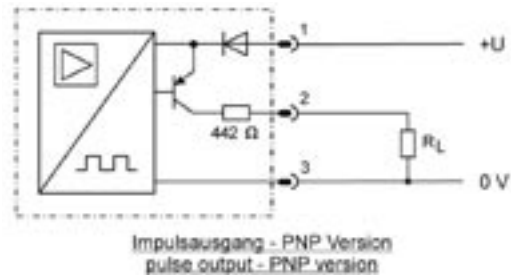
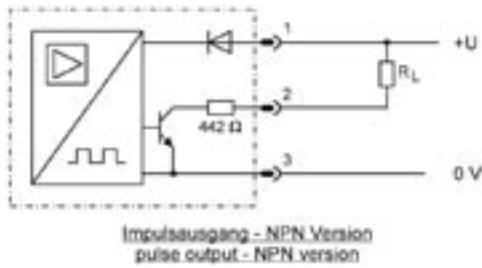

Technical specifications HT

Sensor Unit

Medium temperature	-40°C210°C
Number of pick - ups	1 or 2 pick ups
Pick - up	magneto-resistive
Electrical Connection	cable gland
Seals	FPM or EPDM

Amplifier Pick-up system for high temperature range HTS 1

Supply voltage	$U_b = 10 \dots 30V$	DC +/- 10%
Current consumption	$I_b = \text{ca. } 18\text{mA}$	(idle motion, without lead)
Signal output PNP	High Sign.: $U_s = U_b - 1V$; $I_s = 25\text{mA max}$	
Signal output NPN	Low Sign.: $U_s = 0V$; $I_s = 25\text{mA max}$	
Electrical Connection	4 pol. Round plug	M 12
Max. ambient temperature	-20°C 50°C	
Protection - class	IP 64	
Pull - Down resistor R_c	4.7 10KΩ	PNP-Version
Pull - Up resistor R_c	4.7 10KΩ	NPN-Version

Dimensions flow meter HT

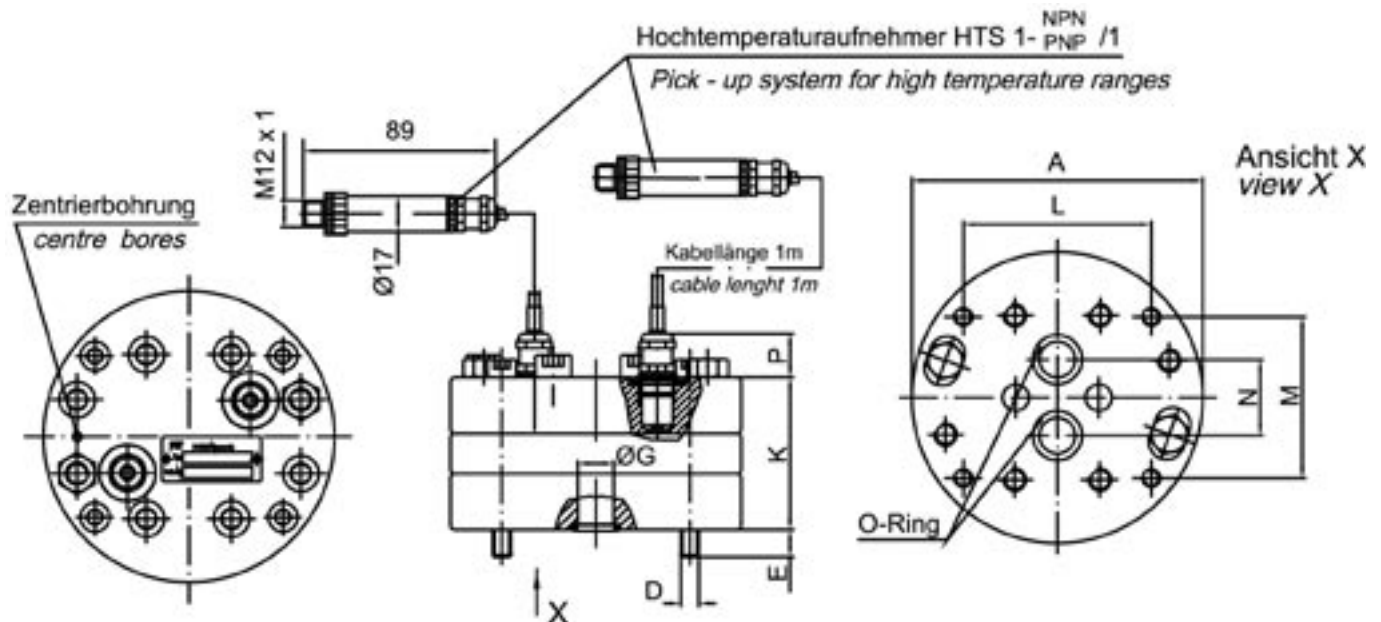

size	A	D	E	øG	K	L	M	N	P	O-Ring	Weight
VS 0.04*	100	M6	11.5	ø 9	59	70	40	20	22	11 x 2	3.3
VS 0.1	100	M6	9	ø 9	61	70	40	20	22	11 x 2	3.3
VS 0.2	100	M6	9.5	ø 9	61	70	40	20	22	11 x 2	3.6
VS 0.4	115	M8	11.5	ø 16	63.5	80	38	34	22	18 x 2.62	4.9
VS 1	130	M8	12.5	ø 16	68	84	72	34	22	18 x 2.62	6.7
VS 2	130	M8	12	ø 16	85	84	72	34	22	18 x 2.62	8.3
VS 4	180	M12	20	ø 30	110	46	95	45	12	36.17 x 2.62	18.3

*only as single-channel version available

Accessories HT

Distribution cable for connection of two HT-pick-ups on a VSE-connecting cable.

Connection diagram 2-channel HT-pick-up system

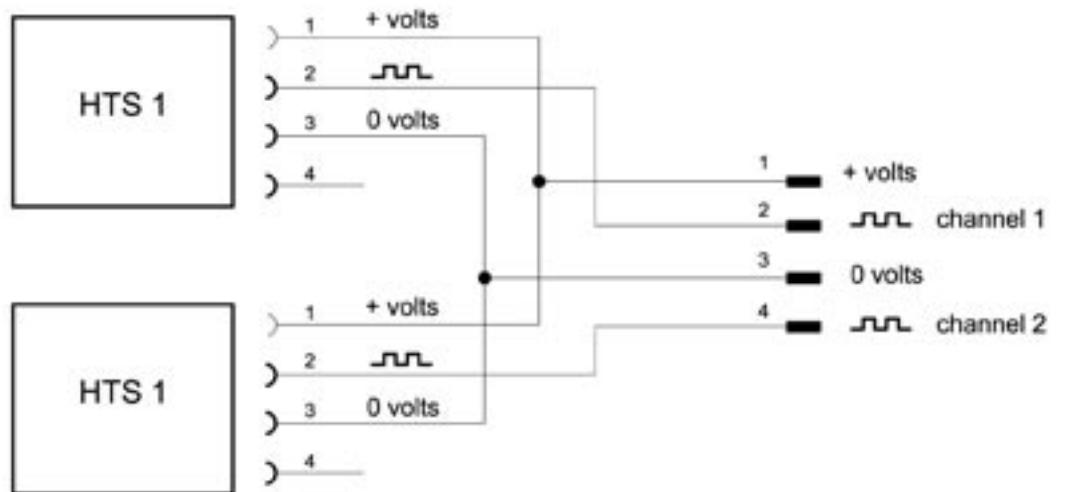
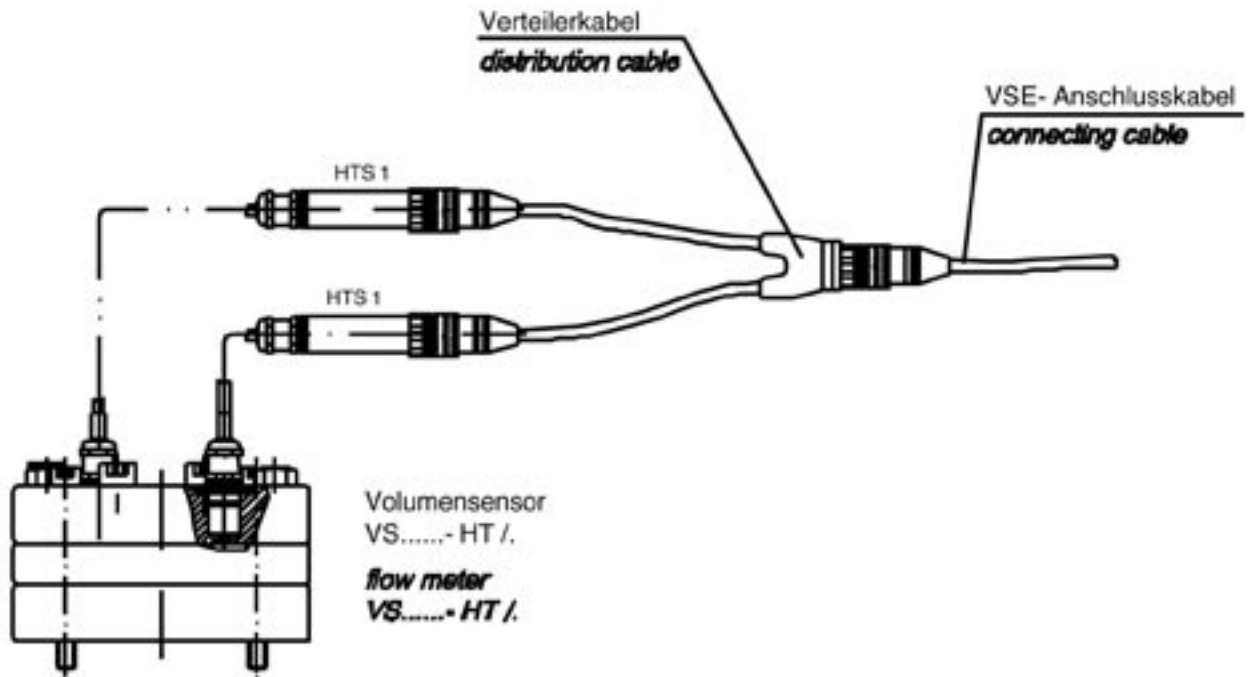



INSTRUCTIONS MANUAL



Keep for future use!



LOW PRESSURE CASSETTE FILTER

Serial Number:



VR COATINGS PVT.LTD.

OFFICE: J-138, MIDC PUNE – 411 026, INDIA.

TEL : + 91 - 20 - 30781022 / 27130331

E-MAIL: vrcoatings@eth.net

**Factory: Plot No.136, Sector No.7, PCNTDA,
Bhosari, Pune – 411 026, INDIA.**

TEL: + 91 – 20 - 30781034

E-MAIL: service@vrcoatings.com

Mr. Pascal D'souza (Technical Director)

+91- 9822655891



WARNING AND SAFETY INSTRUCTIONS

⚠ WARNING



Read and understand instruction manual before use and maintenance. Observe on warnings.



Do not use spray materials containing reactive solvents with equipment containing aluminum, galvanized or zinc coated wetted parts. e.g. Dichloromethane and ethylene chloride can chemically react with aluminium and galvanized or zinc coated parts and cause explosion hazard.

⚠ WARNING



Do not process flammable, explosive, toxic or otherwise hazardous materials without first performing an appropriate hazard analysis.

VR Coatings cannot be an expert in the chemical and biological properties of the infinite number of materials that could be processed in this machine. As sold by VR Coatings, this machine is not designed to safely process hazardous materials unless additional precautions are taken.

Before processing any material that are (or can react to become) flammable, explosive, toxic or otherwise hazardous, the user must perform a thorough hazard analysis and risk assessment of the entire process and determine the best way to deal with the hazard(s) identified, including contingency plans for dealing with processing errors and object conditions.

▲ WARNING



SKIN INJECTION HAZARD. Protect hands and body from high-pressure fluids. Relieve pressure before disconnecting hydraulic or other lines and tighten all connections before applying pressure. In case of accidental skin injection, seek immediate” Surgical Treatment”. Failure to follow this warning can result in amputation or serious injury.



IF YOU ARE INJECTED, SEE A PHYSICIAN IMMEDIATELY. DO NOT TREAT AS A SIMPLE CUT!



- NEVER attempt to force the flow of fluid backward through the gun with your finger, hand or hand-held object against the gun nozzle.



- Before flushing system, always remove spray tip and adjust fluid pressure to lowest possible setting.

▲ WARNING



COMPONENT RUPTURE The system is capable of producing high pressure all components in the system must have a maximum working pressure capacity, not less than the pressure rating of the pump. **SERVICING** Before servicing, cleaning or removing any part, always shut off power source, carefully release pressure in fluid portions of the system and set safety locks on guns and equipment.



PRESSURE RELEASE PROCEDURE

1. Shut off pump (Close main air supply valve and back-off air regulator).
2. Open drain valve and actuate the gun to release fluid pressure from entire system.
3. Close drain valve when you are ready to spray again.

▲ WARNING



High velocity flow of material through equipment may create static electricity. All equipment being sprayed must be properly grounded to prevent sparking, which may cause fire or explosion.



Due to static electricity potential generated by the high velocity of fluid through the pump, hose and tip, sparking may occur and the system may be hazardous. This can result in an explosion and/or fire, if every part of the spray equipment is not properly grounded. Be sure that both the object being sprayed and the airless equipment are grounded.

This can be done by attaching a static wire to water piping or building structural members known to be earthen. If the hose does not contain a static electricity conductor, a static wire must be attached from the spray gun to the earth.



ALWAYS follow the coating or solvent manufacturer's safety precautions and warnings. Never spray flammable material near open flames, pilot lights or any other source of ignition.



If you experience any static sparking or slight shock while using the equipment, stop spraying immediately. Check the entire system for proper grounding. Do not use the system again until the problem has been corrected.

⚠ CAUTION



FLUSHING/CLEANING

Always flush the unit into a separate metal container with the spray tip removed and the gun held firmly against the side of container to assure proper grounding and prevent static discharge, which could cause serious bodily injury.

⚠ CAUTION



Ensure that temperature of hot fluid used in the equipment shall not exceed 80% of the self-ignition temperature of the gases/solvent vapour in explosive atmosphere, in which equipment is used.

⚠ CAUTION



Check the compatibility of the solvent used in the equipment with the materials of wetted parts.

Marking on the equipment

CE  h IIb T6 Gb

M.W.P.

OPERATING INSTRUCTION

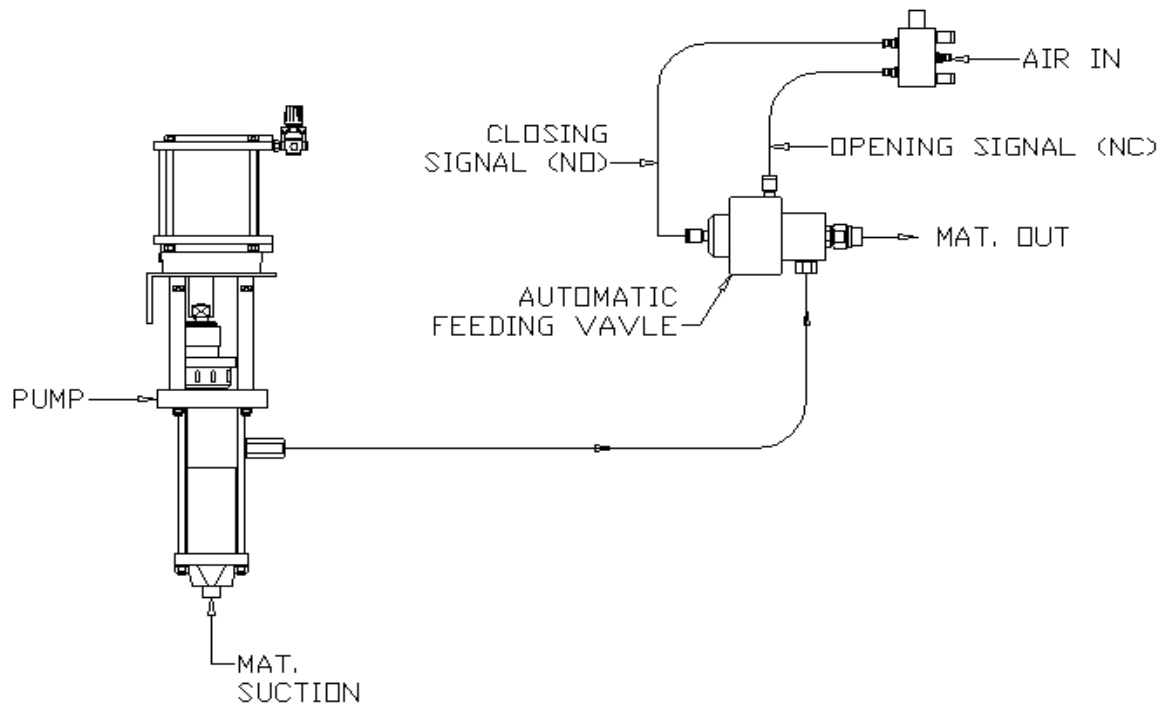

The Typical Installation drawing shown above is only a guide. Contact your VR representative for assistance in designing a system to meet your particular needs.

INSTALLATION

Connections-

Connect grounded fluid line from the pump to the fluid inlet adapter ($\frac{1}{4}$ " BSP for 3.0mm and $\frac{3}{8}$ "BSP for 6.5mm) of the valve. You should install a fluid pressure regulator to control fluid pressure to the valve. Flush the system. A regulator enables you to control fluid pressure more accurately than by regulating air pressure to the pump. In a circulating system, connect the return line from the outlet port ($\frac{1}{4}$ " BSP for 3.0mm and $\frac{3}{8}$ "BSP for 6.5mm) to the back pressure valve. Check capacity of the pump to put number of valves in line. Connect actuating air tubes to 5/2way valve as shown in above fig.



Use sealant on threaded connections as required.



Ensure proper equipment grounding before use to avoid accumulation of static charge.

Pressure Relief Procedure

Whenever you are instructed to relieve the pressure,

1. Stop spraying,
2. Shut off the air to the pump.
3. Actuate the valve to relieve pressure.
4. Open the pump drain valve (required in your system) to help relieve fluid pressure in the displacement pump. Actuating the valve to relieve pressure may not be sufficient. Have a container ready to catch the drainage.
5. Leave the drain valve(s) open until you are ready to spray again.

If pressure is not relieved by following above steps, which means valve or hose is choked.

Loosen the hose and coupling slowly and relieved pressure gradually, and then loosen completely. Clean the valve and hose.

Operation

Use a fluid filter to remove particles and sediment that could choke the tip.

Set the actuating mechanism in such a way that the valve will start spraying or dispensing before meeting the workpiece and stop spraying just after the workpiece has passed.

Set the actuating air to at least 4 bars and start the pump. Adjust the pump speed and pressure to obtain the proper atomization always uses the lowest pump speed necessary to get the results you want.

In a circulating system, adjust the back pressure valve to provide constant system backpressure for all valves while maintaining the proper pressure for fluid circulation.

Service

Always shut off power source and release pressure before you open for servicing.

Keep recommended spears on hand to reduce down time.

Follow pressure relief procedure.



Clean all parts thoroughly when disassembling. Do not use sharp object for cleaning.

Check all parts carefully for damage or wear, replace as needed. Check periodically for leakages from the equipment. If you find leakage, replace seals promptly.

When reassembling tighten all threaded connections securely.

Flushing the system

Relieve the pressure. Start the pump and flush the system with a compatible solvent as explained in the instructions for your pump. Check the system under pressure for leaks; if any are found, relieve the pressure and repair the leaks. Pressurize the system again and make sure the leaking has stopped.



TROUBLE SHOOTING

Check every possible problem and solution before disassembling the valve.

Problem	Cause	Solution
Valve will not stop.	Fluid pressure too high.	Reduce pressure to pump, or adjust fluid pressure regulator.
	Fluid needle binding.	Clean, repair.
	Piston packing binding.	Repair.
	Obstructed or worn needle or seat.	Clean or replace.
Valve will not open.	Pump not operating.	Check pumps operation.
	Fluid line choked.	Clear.
	Fluid valve closed.	Open.
	Choked tips or needle seat.	Clean.
	No trigger or actuator air pressure.	Check, clean all lines.
	Worn or dry piston packing.	Replace.
Gun leakage from back side	Loose or missing lock nut.	Replace and/or adjust lock nut.
	Packing Ring & O Ring worn out.	Replace.



TECHNICAL SPECIFICATIONS

Maximum Working Pressure (for 3mm)	500 Bar.
Maximum Working Pressure (for 6.5mm)	225 Bar.
Outlet hole size	3.0mm/6.5mm
Switching air inlet pressure	Up to 6 bar (Double acting)
Inlet / Circulation ports	1/4" BSP (F) for 3 mm, 3/8" BSP (F) for 6.5 mm
Outlet port	3/8" BSP (F) Swivel
Wetted Parts	304 Stainless steel, Tungsten Carbide Valve, PTFE.

INDEX

DECLARATION OF CONFIRMITY	1
WARNING AND SAFETY INSTRUCTIONS	2
TYPICAL INSTALLATION	6
TROUBLESHOOTING	9
OPERATING INSTRUCTION	10
DRAWINGS AND PARTLISTS	
NOTES	11
WARRANTY	12



WARRANTY

VR Coatings warrants all equipments manufactured by us, as long as it is bearing original identification plate, to be free from defects in material and workmanship for a period of one year from ex-works date. VR Coatings will repair or replace any part of the equipment proven defective. The warranty applies only when the equipment is installed, operated and maintained in accordance with VR Coatings written recommendations.

Warranty claims found to be defective shall be verified and confirmed by VR Coatings.

Our warranty does not cover and VR Coatings shall not be liable for any malfunction, damages, or fair wear and tear caused by faulty installation, misuse, abrasion, corrosion, inadequate or improper maintenance, negligence, tempering, accident or incorporation of non VR Coatings parts, non observance of VR Coatings recommendations.

This warranty only consists of replacing the parts returned to our plant prepaid transportation and proven defective by us. If inspection of the equipment /part does not disclose any defect in material or workmanship, repairs will be made at a reasonable charge, which charges may include the cost of parts, labor and transportation. VR Coatings shall not be liable for any losses resulting from a production breakdown.

Material bought in equipment, which is sold but not manufactured by VR Coatings, will be subject to the manufacturer's warranty. VR Coatings will provide purchaser with reasonable assistance in making any claim for breach of these warranties.

Date of sales



NOTES

Lined area for notes.

